

Clinton County News

Serving the Clinton Area Since 1856

118th year

34 pages

ST JOHNS, MICHIGAN 48879

Volume 17

August 23, 1973

DeWitt elects mayor, councilmen . . . again

By Jim Edwards,
County News Editor

DEWITT — Another chapter in the stormy story of DeWitt city politics was closed Tuesday night when 374 voters

turned out to elect a new mayor and 2 new councilmen. The election became necessary after a recent recall election ousted 3 of 4 elected officials listed on the recall ballot.

New mayor of DeWitt is Murl Eastman, the 3d man to hold the position since the November regular election.

Eastmen defeated Sarah Fike 296-60. Elected to council positions are Arthur Newman with 220 votes and William Drouin with 147 votes. They defeated J. Dale Bohm (138 votes), Barbara Warren (109 votes), Margaret Faught (64 votes) and Steward Hall (32 votes). Unofficial reports indicate Hall changed his mind about running for office after he filed and did not actively seek the council position.

The election changes the make-up of the council for the 3d time in a year.

The first change came when resignations were submitted by councilmen, over a possible conflict of interest in having councilmen as members of DeWitt Development Corporation.

Following those resignations, the November election brought 4 new members of the council, Stanley Tenney, Ron Mull, Wayne (Gus) Wilcox and Gary Gillespie. A 5th member was Frederick (Bill) Shaver who was appointed to fill the vacancy created by the election of former councilman, elected mayor Raymond DeWitt, now former mayor.

DeWitt, Shaver, Tenney and Robert Ballard were later listed on recall petitions, a result of a dispute which erupted over a zoning change granted to Donald Ducharme.

That zoning change, over the objection of several Lake Geneva residents, allowed Ducharme to build condominiums in the Lake Geneva development.

In that recall election, DeWitt was recalled as mayor and Ballard and Tenney were recalled as councilmen. Shaver was not recalled.

The recall ousted the only 2 men, DeWitt and Ballard, who had been on the council previous to the November election.

Ironically Eastman opposed Raymond DeWitt in November for election to mayor. They were running for the mayor's spot vacated by Robert Keck who chose not to seek reelection.

It was Keck who was called upon following the recall to take over again as mayor until the Tuesday election was held. Another former city councilman, Keith Blizzard also returned to the council to fill a vacancy until the election.

If things hadn't been confusing enough, prior to the recall election 2 city officials, Charles Anderson and Daniel Elliott submitted their resignations.

Anderson was chief of police and Elliott was city administrator.

So . . . if there are those who can't figure "who's on first" after 4 mayors within a year, 14 councilmen in the same period, a change in police chiefs and the latest in city administrators' resignations the following is the current make-up of DeWitt city government.

Mayor is Murl Eastman flanked by councilmen Shaver, Mull, Wilcox, Gillespie, Newman and Drouin.

The police chief who replaced Anderson is Wendell Myers and there, currently, is no city administrator.

If that helps to simplify it, there's more. Rumor has it that 2 councilmen in office since November may resign.



Robert Dittmer, owner of Radio Station WRBJ in St Johns, presents US Savings Bonds to Vickie Thelen and Charles Tait who were named as Outstanding 4-H Girl and Boy at the Clinton County 4-H Fair last week.

Three school districts announce opening dates

CLINTON COUNTY — St Johns, Fowler and Bath school systems recently announced that school will begin Sept 5 for their students.

Staff meetings will be conducted Sept 4 for Fowler Public School employees, with students reporting for all-day sessions Sept 5.

Buses will operate on the same routes as last year, with adjustments made at the end of the 1st week. Anyone who moved into the district and has not already enrolled their students is requested to do so as soon as possible. This may be done at the high school office between 8 am and 1 pm.

The hot lunch program will cost, on a weekly basis, 35¢ for 1-3 grades, 40¢ for 4-6 grades, and 45¢ for 7-12 grades. Single lunches cost 5¢ extra. Because the special milk program has been discontinued by the USDA, white milk will be 7¢ and chocolate 8¢, if purchased without lunch.

High school students may pick up their enrollment card, books and supplies at the high school cafeteria Aug 28-30 between 8:30 am - 2:30 pm.

School will start for all St Johns students Wed, Sept 5, and will last all day, with a full day also scheduled for Thursday. There will be no school for students Friday. Classes resume again on Monday the 10th.

All parents new in the St Johns area who have not registered their children are asked to do so at the superintendent's office located in the high school.

School bus routes will be published in the Aug 30 edition of the County News. School for Bath students also begins Sept 5, with a full day.

Split sessions will be held again for this year, for junior and senior high students, with high school classes beginning at 6:45 am and lasting until noon. Junior high students will attend from 12:15 pm until approximately 5:15 pm. Grades 1-6 will begin at 8:30 am.

Cattle thefts continue

CLINTON COUNTY — The cattle rustlers are at it again. This time Leon Schumaker, 8256 S Francis Rd, DeWitt was the victim. He reported the theft of an all-red bull calf to the Clinton County Sheriff Dept on Aug 11.

Five break-ins at homes in the area have occurred recently. Bernice Rice, 3400 W Townsend Rd, St Johns, returned home Aug 16 after being away for a few hours and discovered a TV set and binoculars were missing.

The George Schultz residence at 10339 S Lowell Rd, DeWitt, was the scene of another break-in on Aug 14. Stolen were 3 rifles and shotguns.

Two Laingsburg residences across the road from each other were victimized. Jeff Sickle, 3748 E Lehman Rd reported the theft of a TV set, 35 mm camera, field glasses, watch, shotgun and a sum of money. A neighbor, Lynn Miller, 3725 E Lehman Rd, had shotguns, rifles, stereo equipment and

ammunition stolen, totalling \$1685.

Arlo Corwin, 4714 E Maple Rapids Rd, Elsie, reported stolen tools, battery, seat covers and clothing from a car parked on his property Aug 7. The value of the stolen items was listed at more than \$150.

Gary Lee Early, 22, Route R, Dexter Trail, St Johns, was found guilty in District Court of assault and battery, which occurred Aug 12 at the Dennis Thelen farm on Pratt Rd. Bill Kirkpherc of Dexter Trail was the victim. Early will be sentenced Aug 27.

A complaint was received Aug 10 from Jerome Feldpausch of Dexter Trail, St Johns. Arrested subsequently for malicious destruction of property were Lyle Feldpausch, 22, Colony Rd, St Johns; and Albert Thelen, 19, Fowler. Thelen pleaded guilty in District Court, and will be sentenced at a later date. Feldpausch demanded examination, which will also be held at a later date.

Stores announce Monday evening shopping hours

ST JOHNS — Several downtown St Johns business owners and managers have announced they will begin to remain open on Monday evenings as a shopping convenience.

Those who have announced they will be open for Monday evening shopping hours are J.C. Penney, Bennett's Jewelry, Julie K. PX Store, St Johns Furniture, Colonial Restaurant, Town

and Country Carpet, Lamberts Fabric, Harr's Jewelry, DePeal Music Center, Rehman's Clothes, Economy Shoes, Parr's Rexall Drugs, D&C Store, St Johns Music Center, Hobby-Lobby, D&B Party Shoppe, Quality Discount, and the Carol Ann Shop.

The new store hours until 9 pm for participating stores begins Aug 27. Friday evening hours until 9 pm will remain as they have in the past.

Explain reasons for bond proposal

City answers sewer questions

1. Q: Why is the sanitary sewer project necessary?

A: The answer is three fold. First, the capacity of the existing plant has been surpassed in many stages of the treatment works during only average flows. Heavy daily flows of twice the designed capacity which have been experienced in turn causes raw sewage back-ups into residential basements. This plant expansion would add the needed capacity for the increasing average flows, and an 800,000 gallon equalization basin to control high level flows. Second, the present plant's degree of treatment does not meet the state's guidelines of pollution control. Third, the State has ordered the City to improve the degree of treatment to remove phosphates and anticipate a tertiary treatment order. The new plant expansion would add the needed capacity, and bring our level of sewage treatment to the levels of order and antipolluted by the State.

2. Q: How much is the total cost to

update the sanitary system?

A: The total cost of the plant expansion and the needed new sanitary line and lift station would be funded as follows:

Local	\$ 902,000	20%
State	225,500	5%
Federal	3,382,500	75%
	\$4,510,000	

The Federal Environmental Protection Agency and State grants are proposed to fund 80% of this City facility.

3. Q: For how many years will the new parts of the sewer last?

A: The plant expansion is designed to meet a 1990 projected population of 13,000. Existing sanitary problems and state orders have necessitated this plant alteration, and therefore it is only wise and prudent to consider the City's future in the design.

4. Q: How long will it take to complete the project?

A: The engineers estimate the proposed storm sewer project could be completed within a year after awarding of the contract. The sanitary and plant expansion is estimated to approximately 15 months after the awarding of contracts.

5. Q: I live in an area already equipped with adequate sanitary sewer service. Why should I vote to spend money on a system I don't need.

A: The burden of meeting State pollution standards is certainly a community responsibility that will provide for a better environment both now and in the future for all of us. And the fact that an individual has not experienced sanitary back-up is not a guarantee that he may not in the future, but more important the cost of that individual's adequate sewer was defrayed by others before. This can only be viewed as solving a community problem which can only grow more severe if not taken care of. Also, the 80% Federal and State monies may not be available in the future

6. Q: I live in a \$25,000 home. How much will it cost me per year in extra taxes?

A: The proposed millage increase will be up to 4.42 mills which would bring the City rate to 16.42 is comparable to the 1966 rate. With no major budgetary cuts this City wide major project will still come close to the rate range levied some five years ago, for general operating procedures. Also, the amount of tax paid could decrease as the City's evaluation went up and the bond were paid off. Originally, a home owner with a house valued at 25,000 assessed at \$12,500 would pay approximately \$55 yearly in taxes for the project.

7. Q: What areas of town will have new or expanded sanitary sewer lines?

A: The only new sanitary line would include a truck sewer and lift station running from the south end of the City, down Scott Road to the Treatment Plant, with major interceptors to service the Oakland

and Lansing Street area. Although this system would provide direct relief to those homes which have experienced basement back-up and provide sanitary facilities for many homes and areas in the City which have never had these utilities, this one would also serve the remaining areas of the City. This service would be allowed major areas of the City to flow over the new line at existing interceptor points thus relieving the pressure of the northern lines to the plant which carry the majority area of the city sewage.

8. Q: Does the storm sewer proposal affect most areas of the City?

A: The storm proposal directly affects by the laying of either new lateral sewers or replacing under-sized sewers, 13 of the City's 15 drainage areas. The reduced flooding of city streets will be the immediate affect and also providing outlets for areas previously served incorrectly by catch basins hooked to sanitary lines with new and correct sewers. The proposed truck sewers and holding ponds will allow

for the adequate carrying away of water and for the final dispersment of it.

9. Q: What is the cost of the storm sewer proposal?

A: The total cost of \$1,450,000 is included in the 4.42 mills. The breakdown of proposed expenditures is as follows:

Truck Sewers	\$830,126
Lateral Sewers	172,459
Replacement Sewers	351,321
Holding Ponds	96,000
	\$1,449,906

10. Q: Is there a reason why the two systems must be implemented together?

A: Total cure of the community's storm and sanitary water problems can only be effectively administered with the implementation of both systems. The problems are so intertwined that construction of only one system would only be to treat the symptoms and not to effect the cure.

Police investigate

Gunshot wounds man

DEWITT — The City of DeWitt Police Dept is currently investigating a shooting Monday night at 907 Pine St, DeWitt, involving a Mason man and a DeWitt man.

Shot in the stomach was Ralph D. Purvis, 29, of 50 S Onondag Rd, Mason. The DeWitt man involved is Douglas Edward Foster, 30, 907 Pine St.

DeWitt Police, assisted by the Clinton County Sheriff's Dept went to the scene

where they received continuing reports of the incident.

DeWitt Chief Wendell Myers said Purvis told police he was putting the 22 bolt-action single shot rifle down when it discharged wounding him in the stomach.

Chief Myers said Foster said Purvis took the gun away from him to prevent him from shooting himself.

CHIEF MYERS said both men gave more than one account of the incident and each had referred to talk of shooting themselves.

Clothing worn by Purvis at the time of shooting and the rifle are at the State Police laboratories where tests were scheduled to be conducted.

Purvis was taken to St Lawrence Hospital by ambulance following the 9 pm incident.

Horse, pony owners: get animals vaccinated

CLINTON COUNTY — Owners of horses and ponies are advised to get their animals vaccinated against Equine Encephalitis, according to County Agricultural Extension Director James Pelham.

Although no cases have been reported in Clinton County, more than a dozen cases of the sleeping sickness have been discovered in Kalamazoo and Allegan Counties. Pelham noted that there are more than 1700 horses and 900 ponies in Clinton County.

Pelham advises owners to get in touch with their veterinarian immediately and have their animals vaccinated. There is a brief waiting period before the vaccine is effective.

Pelham said he was hesitant to advise owners against moving their horses, to show at fairs, etc, but added,

"I guess I'd be little reluctant to be moving a horse of my own until it was vaccinated."

Police investigate cattle shootings

BATH TWP — Bath Township Police, in conjunction with the Clinton County Sheriff Dept, are investigating the shooting of 2 Holstein cows Sunday night.

The cows were shot in the head by what Bath chief Myers Steffes theorized might be a high powered rifle. The heads are being examined at

Michigan State University to determine the calibre of bullets used.

The incidents occurred at approximately 9:30 pm at the Gary Sansote farm located at 13661 Center Rd, Bath. Mrs Sansote told officials her father discovered the cattle Monday morning when he went to the barn to feed them.



BUS READIES TO HEAD FOR AKRON, OHIO IN TRIP SPONSORED BY THE CLINTON NATIONAL BANK AND TRUST.

*Clinton County Derby
winner and supporters
visit National Derby*

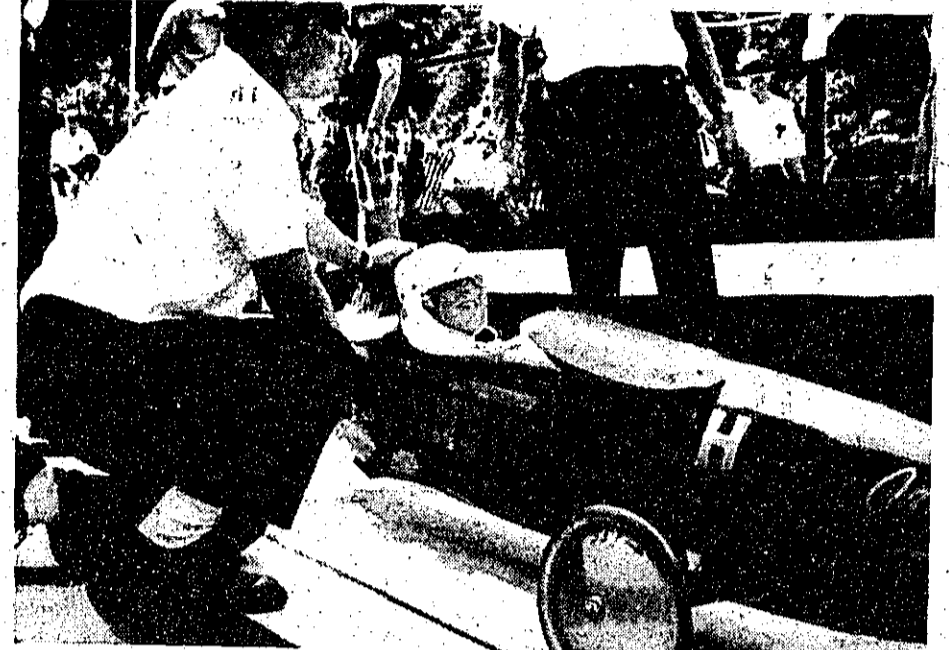

CLINTON COUNTY WINNER, CHARLIE STILES, PREPARES FOR FIRST RACE OF THE FIRST HEAT. STILES WON 2 HEATS AND WAS WITHIN ONE HEAT OF COMPETING FOR THE CHAMPIONSHIP.



CLINTON COUNTY SOAPBOX DERBY FANS VIEW THE COMPETITION.



WEEKEND OF FUN FOR CLINTON DERBY PARTICIPANTS.

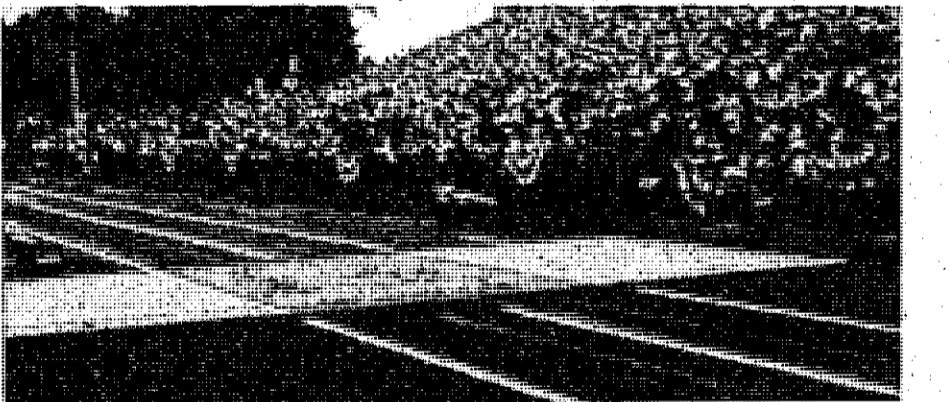

CHARLIE STILES HEADS FOR THE FINISH LINE.

Wickes

Wickes is the Place

for **VALUES** in **BUILDING SUPPLIES**

Prices Good Thru **September 5**

LUMBER
for the handyman

Wickes Dimension Lumber & Building Supplies Department

Wickes Lumber Department handles quality materials. Our carload volume buying means huge savings for you. All lumber is Association grade stamped.

Time Payment Plan
Build now and pay later. See Wickes Credit Chief. He has a TP to fit every need.

Installed Service
Buy it installed. Enjoy your purchase with no work. Put Wickes to work for you.

2" x 4" STUDS
Get your show on the road and get building with Wickes economy studs. Clean and easy to work.

DIMENSION LUMBER
Wickes carries a complete selection of dimension lumber. All pieces are quality materials. Clean and easy to work.

	8'	10'	12'	14'	16'
2" x 4"	1.09	1.49	1.78	2.09	2.38
2" x 6"	1.74	2.18	2.62	3.06	3.50
2" x 8"	2.22	2.92	3.50	4.09	4.66
2" x 10"	3.04	3.80	4.56	5.32	6.08

69¢ each

240 lb. SELF SEAL SHINGLES
Lasting beauty for your home. Attractive colors to choose from.
\$3.55
Bundle Reg. \$3.68

1/2" CDX Exterior PLYWOOD SHEATHING
Association grade stamped. Exterior glue for outdoor use. Strike up the band and save.
\$5.49
4' x 8' Sheet

OWENS/CORNING Fiberglas® INSULATION
3 1/2" thick x 15" wide
Keep your home warm in winter, cooler in summer. Kraft paper moisture barrier.
\$4.47
70 Sq. Ft. Roll Reg. \$5.01
6" thick x 15" wide 50 Sq. Ft. Bag **\$5.98**

5/8" Decorative ROUGH SAWN SIDING
Decorative, rough sawn fir siding for the rustic look. 12" on centers.
\$12.99
Reg. \$14.99
4' x 8' Sheet

BIG GALLON-ANNUAL SALE BIG

PAINT

NOW THROUGH LABOR-DAY

HOUSE PAINT \$9.47 Latex A 100 \$8.27 Gal. Limit 100 Gallons	OIL BASE HOUSE PAINT \$8.27 Limit 100 Gallons
Alkyd ENAMEL \$11.97 Kem-Glo \$10.47 Gal. Limit 100 Gallons	Latex WALL PAINT \$8.97 Super Kemtone \$7.67 Gal. Limit 100 Gallons
Ranch Red \$6.97 \$5.88 Gal. Limit 100 Gallons	Barn Red \$7.97 \$6.38 Gal. Limit 1000 Gallons

COUPON

GOOD FOR AN EXTRA DOLLAR OFF ON LATEX, REGULAR OIL, BASE, KEMGLO, SUPER KEM-TONE ONLY
Expires Labor Day 1973

SEE US FOR YOUR PAINT NEEDS

Finkbeiner's Pharmacy
"Your Family Health Center"
FOWLER, MICHIGAN

Wickes Lumber

3680 West Monroe Road
ALMA, MICHIGAN
Telephone: 463-4936

STORE HOURS: MON.-THURS. 8 a.m. - 6:30 p.m.
FRI. 8 a.m. - 9 p.m.
SAT. 8 a.m. - 4 p.m.

THESE GRAND OPENING VALUES ALSO AVAILABLE AT THE WICKES CENTER IN CLARE #0016-73

DeWitt Twp sets land use hearing

DEWITT TWP -- The DeWitt Township Planning Commission will hold a public hearing on its

proposed land use plan Sept 18 at 7:30 pm in the Township Hall, 780 E Wieland Road, to get public opinion on the plan.

The land use plan was developed in a 4-phase program. Phase 1 involved inventorying and analyzing the township's current

situation.

Population was analyzed to find age-sex ratios and composition, family income

levels, labor force characteristics, and population distribution.

Natural features were studied to determine agricultural lands that should be preserved, and what soils would limit future development.

Community facilities were inventoried to learn the present and future capabilities for usage of schools, utilities, parks, police and fire protection, and governmental buildings.

The transportation system was analyzed according to present level of usage, conditions, and the capacity of the circulation network to meet future needs. To further assist the analysis, a map of existing land use was produced.

plate fees go to the Motor Vehicle Highway Fund.

Before distribution is made, collection costs are deducted, along with 1.5% of the total for the Waterways Commission and 1/2 cent of the gas tax for the new General Transportation Fund. During the 2nd quarter only, \$1 million is set aside for a newly established "critical bridge" fund.

The Dept of State Highways receives 44.5% of the remainder, counties share 3.7% and incorporated cities and villages receive 19.8%. DeWitt's share amounts to \$8,986 for the 2nd quarter. Eagle receives \$1029, while Elsie is to receive \$5314.

Fowler gets \$4306 and Maple Rapids receives \$3452. Ovid's share is \$7740, while Pewamo will receive \$3638.

St Johns is entitled to the largest amount, totaling \$28,944.

PHASE 2 centered around the identification of community trends and problems.

By building on positive features and suggesting policies to minimize past development problems, more desirable growth patterns will be encouraged in the future.

Phase 3 focused on formulating goals and policies relating to future growth. In this phase, policies for land use classifications, community facilities, and future transportation networks were established.

The goal of the Sept 18 public hearing is to get the public's comments and recommendations on the plan. "Even without planning DeWitt Township will continue to grow," said Planning officials,

but through the DeWitt Township Planning Commission, residents can help determine the direction of their township's growth.

The DeWitt Township Planning Commission started working on the plan with the Tri-County Regional Planning Commission in March, 1972.

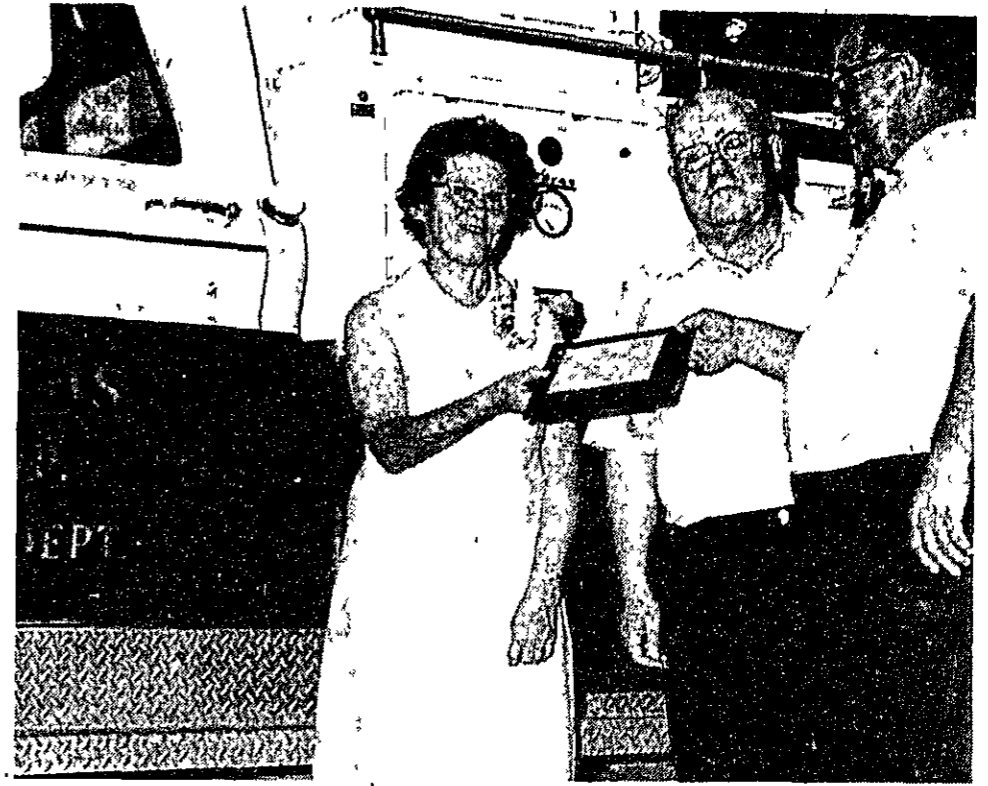

Clare Snyder (right), former Fowler fireman and Dallas Twp trustee, presents Helen Fink and her brother Harold with a plaque in recognition of their outstanding service to the Fowler Fire Dept. The brother and sister team dispatched fire trucks 24 hours a day for 39 years.

County receives \$347,144 from motor vehicle fund

LANSING -- Clinton County's share of 2nd quarter Motor Vehicle Highway Fund monies amounts to \$347,144 this year, up more than \$72,000 over last year's total of \$274,473. Funds are

currently being distributed to county and incorporated cities and villages, according to the State Highway Commission.

Net receipts of the Highway Fund during April, May and June of this year in-

creased 23.5%, attributed primarily to a 2¢ per gallon increase in the gasoline tax which became effective Feb 1. Diesel fuel tax did not go up.

All State gasoline and diesel fuel taxes and license

Public is invited to open house honoring Earl Haas

July 31 marked the end of an era for Cooperative Extension work in Clinton County. On that date County Extension Director F. Earl Haas officially retired after 38 years of active service to the people of Michigan.

An open house will be held for him and his wife, Norma, Sunday, Aug 26 from 2 until 5 pm at Smith Hall in St Johns.

A short program will be held at 3 pm. No special invitations are being sent because of the large number of people the Haas's count among their friends. The public is invited to attend and wish him well in his retirement.

A book of letters will be presented and those wishing to write should use an 8-1/2 by 11 sheet of paper, leaving a 1-1/2 inch margin. Letters should be mailed unfolded to John Aylsworth, Extension 4-H Youth Agent, 1003 S Oakland, St Johns. Contributions for a retirement gift are being handled the same way.

Haas was born and raised on a farm in the Ravenna-Conklin area of western Michigan and earned his B.S. degree from Michigan Agricultural College in 1935. By the time he returned to



EARL HAAS

his alma mater for a masters degree in 1956 it had been renamed Michigan State University.

Haas' 38 years of service was the longest of any one in MSU Extension. He began his career as a district 4-H agent in Kent, Allegan, Ottawa and Barry counties and served in that capacity for 6 years until being called into military service in 1941.

During World War II he served in the South Pacific area and attained the rank of Lieutenant Colonel before

being discharged in 1945. Upon returning from the war he became County Agricultural Agent of Oceana county and held that position until coming to Clinton county in 1955.

The Haas family reside at 907 W McConnell in St Johns and boast five sons; Terry of Sudbury, Massachusetts, Dick of Bellevue, Washington; Brian of Severna Park, Maryland and Bruce and Doug at home.

Haas is well known throughout Michigan and is held in high esteem by other Extension workers and Clinton county farmers for his broad knowledge of agriculture. In areas of income tax, dairy and farm structures particularly, he is considered to be an expert.

He has been a member of the Episcopal church for many years and has served on the vestry and in several other capacities. He is a long time member of the St Johns Rotary Club and served as its President in 1966-67.

Earl has not retired to a life of leisure. During the Clinton County 4-H Fair he was just as busy as always with no visual evidence he had retired. He is a very active person and it's just not his way to stop working.

NOTICE OF PUBLIC HEARING

SEPTEMBER 18, 1973
DEWITT TOWNSHIP
FUTURE LAND USE PLAN

The public is hereby notified that on September 18, 1973 at 7:30 p.m., a Public Hearing will be held to present the Proposed Future Land Use Plan for DeWitt Township. The meeting will be held at the DeWitt Township Hall, 780 E. Wieland Road, Donna B. Syverson DeWitt Township Clerk

16-2

Post Office accepting applications

ST JOHNS -- Postmaster Keith A. Mishler announced today that applications are now being accepted, and examinations will be given to establish a register of eligibles from which future clerk and city carrier vacancies in the St Johns Post Office will be filled.

No experience is required. All applicants will be required to take a written examination, requiring approximately 3 hours, designed to test aptitude for learning and performing the duties of the position.

Interested persons may

obtain an application at the St Johns Post Office which must be submitted before September 14, 1973.

INSURANCE FOR EVERY NEED!

HOME-FARM BUSINESS AUTO

CITIZENS MARINE
a member of
The America Group

LANTERMAN INSURANCE

200 W. State, St. Johns, PHONE 224-7614 BRUCE LANTERMAN

Due to Gasoline Shortage

MOORE OIL CO.

909 E. STATE ST. JOHNS

Must Make The
Following Announcements:

**ALL CHARGE ACCOUNTS
MUST BE PAID WEEKLY**

— ALSO —

**ALL PAST DUE
ACCOUNTS MUST
BE PAID BY
SEPT. 1, 1973.**



MOORE OIL CO.

909 E. State St. ST. JOHNS Ph. 224-4726

With YOU

THE CUSTOMER IN MIND, ST. JOHNS MERCHANTS NOW
OFFER NEW SHOPPING CONVENIENCE. . .

Starting Aug. 27

THE FOLLOWING MERCHANTS WILL BE

OPEN MONDAY NIGHTS

THE REGULAR FRIDAY NIGHT SHOPPING HOURS WILL CONTINUE AS USUAL

<ul style="list-style-type: none"> Julie K Shop Rehmann's Parr's Drugs Harr's Jewelry Quality Discount Hobby Lobby <small>(Starting September 10)</small> Economy Shoes D & C Store DePeal's Music Center 	<ul style="list-style-type: none"> Town & Country Carpets Colonial Restaurant Bennett's Jewelry J. C. Penney Carol Ann Shop Lambert's PX Store D & B Party Store St Johns Music Center
--	---

St Johns Furniture

Clinton County News

Family and Society

They're engaged



JOAN ROSEKRANS & RICHARD SLOYER

ST JOHNS — Mr and Mrs Keith Rosekrans, 403 S Mead St., announce the engagement of their daughter Joan Marie to Richard Eugene Sloyer of Kalamazoo, son of Mr and Mrs Eugene Sloyer of Mecosta.

The bride-elect is a 1971 graduate of St Johns High School and a 1973 graduate of Ferris State College. Her fiancé graduated from Ferris in 1972 and is employed by Kal-Aero, Inc., Kalamazoo. He is a member of the Air National Guard.

A Jan 11 wedding is being planned.

ST JOHNS—Mr and Mrs Junior N Case, 605 S Swegles St., announce the engagement of their daughter, Micha, to Robert G Berkheimer, son of Mr and Mrs Robert G Berkheimer, 1001 N Eaton St, Albion.



MICHA CASE

The bride-elect is employed by Michigan State and attends Lansing Community College. Her fiancé, a car salesman at Jack Dykstra Ford in Lansing, also attends LCC. He served with the U S Army.

No wedding date has been set.



MR AND MRS GORDON LEMKE

Porubsky-Lemke vows spoken July 7

BANNISTER — Marriage vows uniting Diane Marie Porubsky, daughter of Mr and Mrs William Porubsky, 9385 E Taft Rd, Bannister, and Gordon William Lemke, son of Mr and Mrs William Lemke, 204 E Pine St, Elsie were spoken July 7 at Bannister United Methodist Church.

White glads, yellow daisies and candelabras adorned the altar for the double ring ceremony performed by the Rev Miriam F DeMint. Janet Swanson provided organ music.

The bride's gown was of patsiole with an a-line skirt and was trimmed in alcoa lace. Her floor length mantilla veil was held in place by a headpiece of alcoa lace. She carried a colonial cascade of white daisies, yellow sweetheart roses, lavender and white miniature carnations trimmed with ivy.

Cheryl Lemke of St Joseph, Mich, was maid of honor. Her other attendants include Jo Ellen Bearup of Elsie; Erna Santrucek, Bannister; Teri Elkins of Elsie and Sherry Fisher, Corunna.

The bridesmaids' gowns were similar except the maid of honor's was lined with lavender. They wore a-line princess style with puffed sleeves and mandarin collars of lavender nylon flocking lined with taffeta. The maid of honor and flower girl, Shirley Porubsky, wore shoulder length veils with daisy headpieces. The

bridesmaids wore clusters of daisies in their hair. Each had an arm bouquet of white and yellow daisies with purple status. The flower girl carried a white lace basket with white and yellow daisies and purple status.

Jim Porubsky of Bannister was best man. Groomsmen included Jim Robbe, Bannister; Don Elkins, Elsie; Mike Fisher, Corunna; and Randy Lemke of Elsie. Rog Carstensen, Brant; Bruce Denovich, Bannister and Mike Denovich of Bannister seated the couple's 150 wedding guests. Scott Winans, Elsie was ring bearer.

A reception at Slovak Hall followed the ceremony with dinner and dancing for 400 guests. Assisting were Betty Mitchell, Deb Spindler, Karen Porubsky, Lorrie Dimond, Annette Sourek, Michelle Denovich, Robin Reha, Sharon Chovance, Deb Forquer and Gaila Garber. Kris Mitchell served as hostess, and Tony Fabus Jr, as host. The cake was baked and decorated by Fern King. Special guest present was Mrs Mary Parks, grandmother of the bride.

Following a wedding trip to Mackinac Island, the newlyweds will reside at 404 W Sickles, St Johns.

The bride graduated from Ashley High School in 1972 and Lansing Business University in 1973. Her husband is a 1966 graduate of Central High School in Crookston, Minn.

Sharon Crell bride of Don Shore

(c)— The Duplain Church of Christ was the scene of the afternoon wedding of Sharon Crell and Don Shore, both of Lansing on Saturday, Aug 4.

The bride is the daughter of Mr and Mrs Charles Crell of Elsie and the groom's parents are Mrs Maxine Shore of Roscommon and Floyd Shore of Lansing.

The Rev Justin Shepard performed the double ring ceremony before the altar decorated with a low floral arrangement placed beneath the Cross. Later it was used to center the table at the reception.

Mrs Nida Dunham provided the traditional wedding music as the bride was given away by her father and mother.

The bride wore an antique ivory full-length gown of lace and chiffon with a shoulder veil. Her fiber flowers in shades of lavender, purple and white were laid in a trail over a white Bible.

Maid of honor Jane Sharp of Lansing wore a floor length gown of lavender chiffon and lace. She carried

a basket of fiber flowers in shades of lavender, purple and white.

James Des Moines of Lansing was best man for the groom while David and Charles Grieve, nephews of the bride served as ushers.

The bride's mother wore a floor length gown of aqua brocade, trimmed in iridescent white with corsage of pink roses. The groom's mother wore a floor length gown of apricot and corsage of yellow roses.

The wedding reception for 150 relatives and friends was held at the American Legion Hall in Elsie with Mr and Mrs Lyle Lipp Jr, uncle and aunt of the bride, serving as host and hostess.

The new Mr and Mrs Shore left on a wedding trip to Roscommon and Mackinac Island, after which they will reside at 821 Vine St., Lansing.

Mrs Shore is a graduate of Ovid-Elsie High School Class of 1970 and employed by Michigan Civil Service. The groom is also employed in Lansing.

Attend Letter

Carriers conference

Mr and Mrs Jack Hawes, Elsie, and Mr and Mrs Gayle Vauconsant, St Johns attended the 69th National Convention of the Rural Letter Carriers Assoc., Auxiliary, and Juniors at the John Marshall Hotel, Richmond, Va.

	Mich	Nat'l
Association Active and Retired	21	918
Auxiliary	15	859
Juniors	7	448
Total	43	2225

Previous to or after the Convention several days were spent touring the Historical places near Jamestown, Yorktown and Williamsburg, Va.

BIRTHS

A girl, Donna Louise, was born to Mr and Mrs Jerry Wiedenbenner of 712 Garfield, St Johns, Aug 14 at Clinton Memorial Hospital. She weighed 6 lbs 5 ozs. The

baby has 1 brother. Grandparents are Mrs Darlene Wiedenbenner and Mr and Mrs Lawrence Dawson. The mother is the former Janet Dawson.

Melba Beauty Academy

NATIONALLY ACCREDITED BY THE COSMETOLOGY ACCREDITING COMMISSION

Clinic Open To The Public
FREE PARKING

CAREER OPPORTUNITIES IN THE BEAUTY FIELD

ALL SERVICES RENDERED BY SUPERVISED SENIOR STUDENTS
New Classes Starting The First Monday of Each Month
For further information, write or call James Lyon, 15557 North East St. Lansing.



Society Deadlines

The deadline for wedding, engagement and anniversary stories and pictures for the County News is 5 pm on the Friday prior to publication. Information must be typed or printed, and should include the telephone number of the person submitting the news. Please keep stories as brief as possible. Occasionally an unusually large amount of news is submitted, in which case articles may have to be published at a later date due to space limitation.



IT PAYS TO SHOP AT
MacKinnon's
BETTER VALUES FOR OVER 35 YEARS

Back-to-School

SIZES 3 - 6x 7-14

- DRESSES
- PANTS
- JUMPERS
- SKIRTS
- LOLLIPOP PANTIES
- SHIRTS

NEW FALL FABRICS

"LITTLE PEOPLE" PRINTS

50% POLYESTER
50% COTTON
PERMANENT PRESS
45" WIDE. **\$1.69** yd.

YARN DYED
SPORTS WEAR

PLAIDS **\$2.29** yd.
48 in. WIDE
10 EXCELLENT PLAIDS

WASHABLE POLYESTER/RAYON **\$2.49**

FLANNEL AND

GLEN PLAID **\$2.98** yd.
MATCHING PLAIN COLORS

ABOUT \$120 LESS THAN 1952

YET TODAY'S GENERAL ELECTRIC REFRIGERATOR OFFERS NEARLY TWICE THE CAPACITY AND CONVENIENCE IN THE SAME SPACE WITHOUT REMODELING COST!

1952
10.6 Cu. Ft.
SOLD FOR ABOUT
\$509.50
Model NH-10J

TODAY'S BEST BUY!
20.8 Cu. Ft.
\$388



Compare!

	1952	1973
Cubic Feet	10.6	20.8
Dimensions	67" high 32 1/2" wide	66" high 30 1/2" wide
Freezer	70 lbs.	243 lbs.
Automatic Defrosting	Fresh Food only	100% no frost
Colors	White only	3 and white
Automatic Ice	Not available	Optional at extra charge

FREEZER HOLDS UP TO 243 lbs!



BUY WHERE SERVICE IS ALWAYS ASSURED

KURT'S APPLIANCE CENTER, INC.

DOWNTOWN ST. JOHNS

PHONE 224-3895



50th anniversary

An open house honoring the 50th wedding anniversary of the Rev and Mrs Edar R. McLaughlin will be held Sunday, Aug 26 from 2-5 pm at Grove Bible Church, corner of Shepardville and Price Rds., St. Johns. Hosts will be their 3 children and spouses, Dr and Mrs Daniel R. McLaughlin of Somers, Conn.; Mr and Mrs Fred D. Hicks of Marshall, and Mrs Walter J. Martini of Saginaw, and 7 grandchildren. Edgar and Noreen McLaughlin were married in Chicago on Sept. 6, 1923. Both are graduates of Moody Bible Institute, Chicago. The Rev. McLaughlin served in France during World War I, is a member of the VFW and does chaplain work in hospitals. Mrs. McLaughlin has been secretary of Clinton County Hospital Auxiliary since Sept. 1962, and does sewing for the hospital. Both are members of Grove Bible Church. Friends are welcome to attend.



MRS THOMAS KAREK

Patricia Wilson, Thomas Karek speak vows

ST JOHNS — Patricia Ann Wilson, daughter of Mrs. Rose F. Wilson and the late Edwin A. Wilson, 1529 S. Lansing St., and Thomas Gene Karek, son of Mr. and Mrs. Frank Karek, Sr., 7544 N. DeWitt Rd., St. Johns, exchanged marriage vows Aug. 10 at St. Joseph Catholic Church.

The Rev. Fr. William G. Hanked performed the double rign evening ceremony. Evangeline Caudy provided organ music.

The bride designed and made her gown, an A-line floor length crepe creation featuring lace bishop sleeves and lace bodice. She also made her fingertip veil of bridal illusion secured by a Juliet cap, and carried a bouquet of white roses with yellow rosebuds and yellow mountainstar.

Sandra Cornell of St. Johns was maid of honor. Julie Pung and Tina Wilson, both of St. Johns, were the bride's other attendants. The maid of honor wore a mint green floor length gown of empire styling with a high neckline and short puffed sleeves. The bridesmaids' gowns were of similar styling in yellow.

Michelle Saylor, Banister, niece of the bride, was flower girl. She was dressed identically to the maid of honor and carried bouquets of yellow primroses with yellow streamers.

Mrs. Wilson was attired in a floor length mint green gown for her daughter's marriage. The groom's mother chose a street length pastel yellow dress. Each had a symposium orchid corsage.

Frank Karek of Lansing was his brother's best man. Groomsman were Louis Wilson, Bath, brother of the bride; and William Wilson of Eureka, also a brother of the bride. David Wilson and Robert Karek of St. Johns seated the guests.

A reception was held at the VFW Hall immediately following the ceremony. Host and Hostess for the event were Mr. and Mrs. Lyman Ringle. Honored guests were Mr. and Mrs. A. P. Caudy, grandparents of the bride.

The newlyweds departed for a honeymoon in Ohio and northern Michigan. The bride is a 1973 graduate of St. Johns High School, and the groom received his diploma from St. Johns High School in 1970.



Celebrate anniversary

Friends and relatives are invited to an open house celebrating the 25th wedding anniversary of Mr. and Mrs. Stuart Sillman, Aug. 26 from 2-7 pm at their home on Dexter Trail. It will be hosted by their children, Mr. and Mrs. Wayne Woodbury, Mr. and Mrs. Richard Sillman, Charles Sillman, Laurie Sillman and their 4 grandsons.

James Tavener receives MS

HOUGHTON — James W. Tavener, son of Mrs. Dorothy from Michigan, was awarded his Master of Science degree in Technological University Aug. 23.

Open house deadline

Anniversary open house articles accompanied by a photo must be in the News office no later than 5 p.m., on Friday to insure coverage in the next edition of the paper.

Manpower Dept in new location

ST JOHNS — The Manpower Department consisting of two Federal Departments of Labor programs; Operation Mainstream and Neighborhood Youth Corps Out-of-School, is now located at 911 E. State St. Suite "C", St. Johns.

Neighborhood Youth Corps Out-of-School provides youth, 16 through 21 years of age with meaningful work experiences, paid wages, and continues out-of-school education and counseling.

Operation Mainstream is an on-the-job training program for adults 22 years of age or older, which gives an opportunity to get experience or increase your experience in the employment world. This program offers paid wages, work experiences, and counseling services during the training period. Assistances is also given to helping the clients find permanent employment at the end of the program. Currently, employment opportunities

that are available to low income families who reside in the Clinton County area include educational, clerical, skilled and mechanical areas.

Persons interested in training or employers interested in trained personnel should contact Doris Dahlke, Manpower Department, at the Clinton County Branch Office of the Office of Economic Opportunity (OEO) at 911 E. State St., Suite "C", St. Johns, or call 224-6702.

Fowler Jaycee Softball tournament scores

O'Connors-St Johns	14	Dry Dock #2 St Johns	16	Simon's Restaurant	4	Simon's Rest-Fowler	6
Crystal Flash-Westphalia	17	Office Bar-Fowler	14	K of C Westphalia	12	Lipperts-Carson City	5
Heralds Dairy Delight CC	8	Schafer's Bar-Westphalia	14	Mill Rats-Fowler	10	Gregory's Midway-Portland	11
Schmitz Standard-Fowler	13	Carson City Realty	7	Gregory's Midway-Portland	0	Dry Dock #1	10
Bruno's St Johns	21	Pine's Westphalia	8	Herald Dairy Delight	6	Bruno's St Johns	7
Dry Dock #2 St Johns	23	Road Runners-Fowler	6	Bruno's St Johns	11	Fowler Bowl	7
B&W Auto Supply Portland	8	Standard Oil-Pewamo	11	Stanard Oil-Pewamo	6	Central Nat'l St J	6
Ray's Tavern Hubbardston	7	Green Door-Lansing	6	Central Nat'l St J	4	EJ's Standard St J	2
Schafer Bar-Westphalia	11	Dry Dock #1 St Johns	5	K of C Westphalia	3	Road Runners-Fowler	3
Fowler Bowl-Fowler	6	Central Nat'l St Johns	14	Green Door Lansing	7	Herald's Dairy Delight	2
Carson City Realty	15	Schafer Heating Westphalia	4	Schafer Heating	1	Clinton Nat'b	6
Pine's Bavarian Inn	12	Fowler Bowl Lounge	7	Clinton Nat'b	6	Action will continue in the	
O'Connors-St Johns	13	EJ's Standard-St J	6	Green Door-Lansing	11	tournament through Aug 31.	
Crystal Flash-Westphalia	11	Lamplight Inn Carson C	6	Dry Dock #1 St Johns	7		
Schmitz Standard-Fowler	12	Clinton Bank	5	Lamplight Inn Carson City	9		

St Johns slowpitch results and standings

American League	W	L	Central Bank Bombers	5	2	Beaufores	3	6	Battle for the Bottom	
Bruno's	7	0	Hub Tire	4	3	Gen Tel	4	5	Aug 28 City vs Holden Reid	6:30
			Silvestri's	5	4	Holden-Reid	2	7		
			E.J. Standard	4	4	Sons of Satan	0	9		
			Bike Shop	3	5					
			City	2	7					
				1	8					
National League	W	L	O'Connor's	8	1				Grand Champion	
			Dry Dock II	6	2				Aug 28 Winner of Aug 27	
			Dry Dock I	5	2				6:30 game vs Winner of Aug 27	
			Clinton Bank	5	3				8:00 game, 8:00.	
									Aug 29 American League	
									All Stars vs National League	
									All Stars, 8:00.	



\$21.95

Saddle Cream/Blue Sand Suede/Leather

Rock around the clock in doo-waahh, doo-aahh shoes from the Pre-Groovy Era.

Nothing like this since '57 Chevies and going steady with Ba-Ba-Ba, Ba-Barbara Ann.

Why? Why do fools fall in love?

OLDIES BUT

Shop Friday Nites 'Til 9
ECONOMY SHOE STORE
First in Foot Fashion with Famous Brand Shoes

ST. JOHNS
121 N. Clinton
PHONE 224-2213

CLASSES! CLASSES! CLASSES!

AT HOBBY LOBBY
Starting **SEPTEMBER 17th**

- KNITTING
- CROCHETING
- BEADING
- NEEDLE-POINT

NEXT WEEK ONLY!

COLUMBIA-MINERVA

NEEDLEPOINT & CREWEL PILLOWS, PICTURES, CHAIR SETS, FOOT STOOLS

1/2 PRICE
Get Your Fall Work Now!

HOBBY LOBBY
221 N. Clinton, Downtown St. Johns, Ph. 224-6226

HOBBY LOBBY
221 N. Clinton St. Johns
Hobby and Craft Kits and Supplies
Hours 9-5:30 Mon.-Thurs. Fri. 9-9 P.M. Saturday 9-Noon

FINAL CLEARANCE Sale!

ON MENS and BOYS CLOTHING - FURNISHINGS - SHOES

MENS Sport Coats
Year round and summer
Values from \$39.50 to \$85.00
ALSO
MENS SUITS
VALUES \$69.50 to \$119

1/2 OFF

OTHER SUITS AND SPORT COATS
Up to **1/3 OFF**

NOT ALL SIZES IN EVERY STYLE
MENS & BOYS
SHOES 1/2 PRICE

1 Group Men's and Boy's
TANK TOP SHIRTS
Sale \$2.99 each, or
2 FOR \$5

Now open Monday and Friday nights for your shopping convenience

REHMANN'S
CLOTHING — FURNISHINGS — SHOES
for DAD and LAD
ST. JOHNS

Save! RCA Summer Clearance!

Don't miss sizzling savings on color TV, black and white TV, radios, stereos! One-of-a-kinds, floor models, some still-in-cartons! Sale-priced now because we must make room for new model shipments. Save big—buy NOW!

Spanish-style AccuColor 60 console
Bright color picture tube, Fiddle-free tuning, AccuColor 60 chassis—80% solid state. Plus decorator wood cabinetry.

only **\$497**
25" diagonal picture W/T

RCA XL-100

Shop Us For Some Real Money Saving Values
KURT'S APPLIANCE CENTER
N. Clinton St. DOWNTOWN ST. JOHNS Phone 224-3895

Charmaine Pearce, Dale Beers wed Aug 10



MRS DALE BEERS

ST. JOHNS -- St. Johns Assembly of God Church provided the setting for the Aug 10 wedding uniting Charmaine Pearce, Route 1, Fowler, daughter of Mr and Mrs Niels Pearce, and Dale Beers of Perrinton, son of Mr and Mrs Elmer Beers of St. Johns.

The Rev Joseph Eger, Jr, performed the double ring service. Sprays of glads and palms with candlebra graced the altar. Mary Ann Barrett accompanied Jewell Eger, who sang "I Love You Truly" and "The Lord's Prayer."

The bride wore a full length gown featuring a rose pattern lace bodice and sleeves with a taffeta skirt enhanced with lace. Her veil was secured by a pill box with pearls trimmed in rose pattern lace. She carried a long stemmed pink rose.

Her attendants were Marilyn Gurden, Owosso; Cecelia Nuoffer, Mt Pleasant; Diane Gurden, Owosso; and Betty Henderson of Owosso. Joy Eger of St. Johns was flower girl, while Nathan Gurdon Fowler served as flower boy. Les Youngs, Fowler, carried the rings.

The maid of honor wore a pink crepe with lace over burgundy gown. The bride's other attendants wore pink and white rayon chiffon gowns lined with taffeta. Each carried a long stemmed white rose. The flower girl was dressed identically to the bridesmaids and carried pink rose petals.

Mrs Pearce wore a floor length blue print gown for her daughter's wedding while Mrs Beers chose a beige floor length gown. Each had a corsage of pink and white carnations.

Mike Ritter, St. Johns; Dave Nuoffer, Mt Pleasant; Dan Shaffer, Fowler; and Joe Eger of St. Johns were the groom's attendants.

A reception was held following the ceremony at the St. Johns Municipal Building for the couple's 150 guests. Assisting were Pat Youngs, Janette Gurden, Rose Ritter, Shirley Marriage, Mary Ann Barrett, Claudia Barrett and Devona Marriage.

Following a honeymoon in northern Michigan, the newlyweds will reside in Fowler.

The bride is a 1967 graduate of Owosso High School. Her husband graduated from Rodney B Wilson High School in 1968



MRS JOHN HOYT

Ann Stone bride of John Hoyt

GRAND RAPIDS -- St. Jude's Catholic Church provided the setting for the July 21 wedding uniting Ann Louise Stone, 2433 Northville; SE, daughter of Mrs Frank Stone, 301 W Baldwin, St. Johns, and John Edward Hoyt of Kalamazoo, son of Mr and Mrs Paul M Hoyt of Clifton, Mich.

with white dotted swiss edging over bright yellow bridal satin. White picture hats completed their ensembles, and each carried wicker baskets of white and yellow daisies with baby's breath.

Mrs Stone chose a multicolored design gown over a white taffeta background, and had a corsage of a white orchid and carnations. The groom's mother wore an ivory lace over turquoise taffeta dress with matching jacket and had a white, orchid and turquoise carnations corsage.

Don Hoyt of Ypsilanti served as his brother's best man. Arnold Switalski and Brett LaMott were groomsmen. George Lancaster seated the guests Thomas John Stone, nephew of the bride, was ring bearer.

A reception for the couple's 130 guests was held at Adrian's Ramona Terrace in Comstock Park. Patricia and Jean Fitzgerald, cousins of the bride, assisted.

Following a week's honeymoon at Cedar Point, Ohio, the newlyweds will reside at 3732 Duke St, Kalamazoo.

The bride is a 1968 graduate of Central Michigan University. Her husband attended CMU, and is affiliated with Phi Kappa Tau fraternity.

The Rev Fr Patrick Cawley performed the double ring ceremony before an altar graced with white and yellow daisies with white glads and greens arranged on a pair of candelabra. Judy Hoyt played the guitar and sang, "First Time Ever I Saw Your Face" and "The Wedding Song," accompanied by organist Donald Hoek.

The bride selected a full length gown of silk organza with yellow ribbon encircling the bodice. The gown featured cap sleeves and a full skirt which swept into a chapel train. Her matching lace cap was attached to a full length veil of bridal illusion, and she carried a colonial cascade of yellow sweetheart roses, white carnations and stephanotis.

Debra LaMott of Grand Rapids served as matron of honor. Bridesmaids included Judy Hoyt, sister of the groom and Kay Shiel, Lynn Ann Stone, niece of the bride, was junior bridesmaid. All wore sheer yellow gowns

Bath

By Mrs Florence L. Witchell

A girl, Sara Anne, was born to Mr and Mrs James Wolkenstein of Dallas, Texas July 23 at Presbyterian Hospital, Dallas. She weighed 9 lbs 13 ozs. The baby has 1 brother and 1 sister. Grandparents are Mr and Mrs Harmon, Wolkenstein and Mr and Mrs Allen Weseman. The mother is the former Barbara Weseman.

Kathy Green entertained about 30 guests at a bridal shower for her sister, Linda Green, Tuesday evening Aug 14 at her home at 4842 Clark Road, Bath.

Linda's wedding to Phillip Wolf, of E Lansing is set for Sept 22. Born to Mr and Mrs Roger Pannebecker, II of Fawn Valley St, Bath Monday at 9 and a son, who will be called Roger Nelson Pannebecker, III. Mrs Pannebecker is the former Arlene Nelson and coffee.

Linda was also honored recently at a shower by Rosie Lehmann and Ruth McMillan, at Ruth's home on Allen St Bath

A boy, Christopher Hoyt, was born to Mr and Mrs Kenneth H Salisbury of R#3 Lowe Rd, St. Johns, Aug 6, 1973 at Clinton Memorial Hospital. He weighed 6 lbs 12-1/2 ozs. The baby has 1 sister. Grandparents are Gordon and Grace Salisbury of St. Johns, and Mrs Margaret Gaisel, Grand Ledge. The mother is the former Carol Ann Gaisel.

Twin boys, Michael Scott "A", 6 lbs 12-3/4 ozs, and Jason Clark "B", 6 lbs 5-1/2 ozs, were born to Mr and Mrs Roger Beebe of 704 S Wight St, Aug 14, at Clinton Memorial Hospital. The twins have 1 sister. Grandparents are Mr and Mrs Bruce Fowler and Mr and Mrs Robert Beebe. The mother is the former Judy Fowler.

A boy, Roberto Florentino, was born to Mr and Mrs Roberto Rafail Hernandez of 304 Michigan Ave, Owosso, Aug 12 at Clinton Memorial Hospital. He weighed 9 lbs 2 ozs. Grandparents are Mr and Mrs Donato Hernandez and Mr and Mrs Daniel Medina. The mother is the former Caroline Medina.

See your friendly Ford dealer...



"HE WANTS TO MAKE YOU HAPPY"

EGAN FORD SALES

200 W. Higham St.

ST. JOHNS

Phone 224-2285

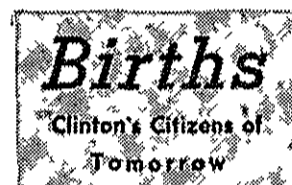

At PARR'S

Visit Our Baby Department

IT'S SMALL... BUT CONTAINS MANY THINGS



BABY DRESSES AND ROMPER SUITS
BABY NIGHTIES AND PAJAMA OUTFITS



BABY SCALES
CRIB MOBILES

DIAPER PAILS
BABY BOOKS

DIAPER BAGS
BABY SPOON SETS

JOHNSON GIFT SETS
BOTTLE STERILIZERS

BLANKETS
BIB SETS

COMFORTER SETS
SWEATER SETS



... and many other things!

SHOP AT YOUR COMPLETE FAMILY DRUGSTORE

PARR'S Rexall DRUG

ST. JOHNS

PHONE 224-2837

Family Theatre
DRIVE IN
ST. JOHNS, MICHIGAN

BARGAIN NIGHT
EVERY THURSDAY
\$1.00 Per Person
Children Under 12 - Free

WED.-THURS.-FRI.-SAT.
Aug. 22-25

20th CENTURY-FOX PRESENTS
THE LAST AMERICAN HERO
PG

When The Legends Die
20th CENTURY FOX
COLOR BY DELUXE
PG

"AN EXCITING AND EXOTIC ADVENTURE!"
WALK ABOUT
COLOR BY DELUXE

SUN.-MON.-TUES.
Aug. 26-27-28

2 Action Packed Films!
"Neptune Factor"
and
"Planet of the Apes"

R. E. BENSON
PLUMBING & HEATING
108 N. Clinton
St. Johns
Phone 224-7033

3 MASTER PLUMBERS
American-Standard Plumbing, Hot Water Heating
Lennox Warm Air Heating and Air Conditioning
CUSTOM SHEET METAL SHOP
47 Years Same Address

Marriage Licenses

Robert J Rehmann, 21, 605 S Mead St, St Johns; Susan M Koenigsknecht, 20, 902 S Scott Rd., St Johns.
 Gary Lee Rivest, 20, 1971 South Meridian Road, Ovid; Debra Jo Clark, 21, 22237 M-57, Bannister.
 Buddy C Hagemann, 29, 1117 Navarre Ave, Toledo, Ohio; Susan K Caesar, 23, R5, St Johns.
 Michael Allan Luznak, 20, 143 East Pine St., Elsie; Patricia Marie Spousta, 19, 510 N Mead St, St Johns.
 Steven Charles Root, 21, 3820 Turner Street, Lansing; Linda Sue Blodgett, 19, 2773 Wildwood Lane, Stevensville.
 Ronald Craig McCarty, 22, 3350 Van Horn Road, Apt 253 Trenton; Linda Anne Thelen, 21, R2 Box 10, Fowler.
 Joseph Paul Yock, 19, 2653 E Taft Road, St Johns; Debra Kay Prior, 18, 3262 W Pratt Road, DeWitt.
 William George Ordway, 19, 703 S Kibbee Street, St Johns; Londa Louisa Holden, 17, 16200 Fenmore Road, Bannister.
 Michael Carl Klein, 21, 11336 W Clinton St, St Johns; Judy Susanne Koenigsknecht, 20, R1, Fowler.
 William J Carr, 20, 2431 Moyer Ave, Wyoming; Heather Ann Lowe, 20, 310 S Franklin, Maple Rapids.
 David J Darling, 20, 121 N 2nd Street Elsie; Regene Sue Howard, 18, 229 West Elm Street, Elsie.
 Richard David Hall, 20, 6353 Park Lake Road, Bath; Judy McVicar, 18, 6353 Park Lake Road, Bath.
 Duane Quentin Price, 24, 1044 Spaulding Ave, Chicago, Chicago, Illinois; Kaye Lynn Montgomery, 19, 15285 Grove Road, Lansing.
 Terry K Lovegrove, 19, 709 W Cass St., St Johns; Deborah A Klein 18, 5267 Francis Road, St Johns



MR AND MRS BRUCE HALE

Barbara Hartsuff, Bruce Hale wed July 14

OID -- Barbara Ann Hartsuff, daughter of Mr and Mrs Kenneth Hartsuff of Ovid, and Bruce A Hale, son of Mrs Katherine Hale of St Johns and Rex Hale, Ithaca, were married July 14 at the United Church of Ovid. The Rev Claude B Ridley, Jr, performed the double ring ceremony before the altar decorated with baskets of white glads and yellow and lavender mums. The bride chose a floor length gown of ivory machelle lace trimmed with satin ribbon. Her high neckline was edged with lace trim. A shoulder length veil was held in place by flowers which framed her face, and she carried a modified crescent arrangement of white snowdrift mums centered with mums. Janet Korf of Corunna was her sister's matron of honor. Clarice Hartsuff, Ovid, sister-in-law of the bride; and Christine Hale of

DeWitt, daughter of the groom; were her other attendants. They were attired in floor length gowns of lavender paisley voile over taffeta with antique lace trim on the neck and long sleeves. Each wore a lavender picture hat and carried a crescent cluster of daisies. The mother of the bride selected a blue street length dress with white trim and white accessories, while the groom's mother chose a peach and white street length dress. Each had a corsage of yellow sweetheart roses with baby's breath. Rodney Hale was his brother's best man. Jim O'Connor and Bill Koivu served as groomsmen. Douglas Hartsuff, brother of the bride; and Ronald Matson, brother-in-law of the groom, seated the guests. A reception for the newlyweds was held at the Elsie American Legion Hall. Those assisting included Betty Drexler, aunt of the bride; Dorothy Sauber, Esther Wilson and Julia Borton. Approximately 150 guests were present. Honored guests were Shirley Trotter of Plano, Texas; and Betty Drexler of Cheboygan. Following a northern Michigan honeymoon, the couple is residing at Centaur Apts, 1500 W North St, Apt C-28, Jackson. The bride is a graduate of Lansing Business University, and attended Lansing Community College.

Bath Twp has quiet meeting

BATH - Business was back to normal once again at Monday night's Bath Township meeting. The only mention of the Park Lake pollution question was made by lake resident Melvin Fisk, who wanted to know the status of the tests being conducted by the Mid-Michigan Health Dept. He was informed that the tests will continue through Labor Day.

Board action was taken to purchase the MR-7 radar unit recently used on a 90-day trial basis by the township police department. The unit costs \$2000 minus the trial price of \$214.68 and is well worth it, according to police chief Myron Steffes. In a letter to the board, Steffes said he feels the radar has greatly reduced the number of speeding violations in the township. Since the trial period began, 130 warning stops have been made, with tickets issued to only 2 persons who were stopped at 2d time. Steffes recommended purchasing the unit, as well as the purchase of signs warning motorists that vehicle speed is radar timed. Treasurer Thomas Woodruff moved, supported by Clerk June Burnett, that the township purchase the radar. The motion included investigating the cost of signs before buying them and reporting back to the

board at their next meeting. Motion carried. The ambulance committee's request that the board allocate \$5000 to get the service started was tabled for further study until the next meeting. Another resident asked the board if everything possible had been done to obtain federal aid to construct a sewer. Trustee John Snider stated his belief that "somebody doesn't like us." He cited Middleton's grant, obtained only 3 months after receiving their Order of Determination, which pays 80% of construction costs. "Mid-Michigan (Health

Dept) has got to be holding us up," he asserted. Township supervisor Roy VanSickle said "to the best of everybody's knowledge, everything has been done." Snider added that the lawyer told him the township has completed all necessary procedures. Bath's Order of Determination states the township must have an operable sewer by Dec 1 of this year. VanSickle told the resident that, theoretically, the state could take Bath to court, order the court to sell bonds and order the township to distribute them. Currently the township has spent \$124,596.82 in

engineering fees for the proposed sewer, in addition to attorney's fees. The next meeting will be held Tuesday, Sept 4 instead of Monday night because of the Labor Day holiday.



We want to wipe out cancer in your lifetime.

Calendar of Coming Events

AUG 28 - Annual meeting of St Johns Women's Bowling Association, 7 pm at Central National Bank. All members are welcome.
 AUG 28 - The Blue Star Mothers will have a potluck supper at 6:30 pm on Tuesday at the Congregational Church. Bring item for Bingo. Regular meeting follows.

Safety belts, when you think about it, it's a nice way to say I love you.

★ CLINTON THEATRE
ST. JOHNS, MICHIGAN

NOW SHOWING 7 NIGHTS WEEKLY!

SCHEDULES ARE:
2 Shows Nightly - 7 and 9 p.m.

Wednesday Night
is
FAMILY NIGHT
All Seats 75¢

Wednesday thru Tuesday
Aug. 22-28

ROGER MOORE
JAMES BOND
IAN FLEMING'S
"LIVE AND LET DIE"

COMING ATTRACTION
A Musical Adaptation of Mark Twain's
"TOM SAWYER"

This Space FOR RENT
Phone 224-2361

We're waiting for you to call

The Clinton County News staff finds it impossible to attend meetings of all clubs and organizations that take place in busy and active Clinton County. And there are insufficient hours to chase the president or secretary of each group to get the stories that arise out of their meetings. Club secretaries are requested to drop us a card or give us a call at 224-2361 and fill us in on the highlights of their meetings and especially about special upcoming activities. If we could financially afford it, we'd employ enough reporters to follow you around and report what you do... and take your picture, too. But our bankers insist on our remaining solvent, paying our interest on time and occasionally making a payment on the principal.

THE CLINTON COUNTY NEWS

Miami BRICKSTONE

It is practical to use a material that hardens instead of softens with age. It is so dense that dirt particles can not penetrate its surface therefore it remains clean. It is produced with metal oxide molecules of color that are forever locked in place. It is produced in modular heights of 1 1/4", 2 1/4" and 3 1/4" in lengths of 23 1/4". It is basically a hard dense limestone product. It is uniform in all dimensions, simplifying installation. It is comparable in cost to many more common masonry materials. It is produced and stocked by a local franchised business firm. It is a full wall thickness similar to brick and stone. It is high in compression strength and low in moisture absorption.

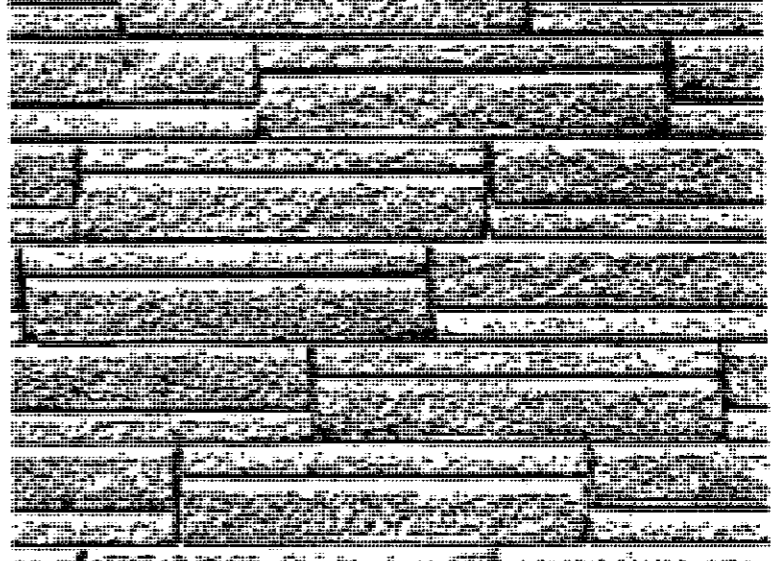

There is a Miami Brick size and color for every architectural style.

The Ultimate Expression of Perfection For Homes



Stays New and Brilliant

The clean, stark grandeur of modern architecture is enhanced by textured Miami Brick that keeps its bright new look year after year, never darkens, chips or shales. Rain washes a Miami Brick building free of dirt and restores its original beauty and brilliance.

Luxurious Interiors

The natural elegance of Miami Brick transforms any home into a showplace, custom-designed for the discriminating home owner. Miami Brick adds warmth and textural interest to interiors - combines handsomely with wood, metal, glass and other materials for enduring walls and fireplace settings. A wide range of pastel hues offers unlimited decorating possibilities.

Remember . . . Beautifying Your Home Adds Comfort, Attractiveness And VALUE!

Assure lasting beauty - the economical way.

Stop in and Discuss Your Needs With Us . . .

KARBER BLOCK CO.

Sand-Gravel-Black Dirt-Mortar Sand

817 Church St. Johns 224-2327

Applications being taken for new Social Security program

LANSING—The Lansing Social Security Office is now taking applications for supplemental security income payments, a federal program scheduled to start in 1974 that will establish a money payment for people in financial need who are 65 or over, or blind, or disabled, according to Roger W. Seamon, social security district manager.

But people already getting state old age assistance, or state aid because they are blind or disabled, don't have to apply, he said. They'll be getting more information later this year about how the program will affect them.

The first monthly payments under the federal program will be made in January 1974. Until then, Michigan Department of Social Services will continue to make payments in the usual way.

People not getting public assistance now who think they may be eligible for the new federal payments should call or write social security to find out if they should apply.

Federal supplemental security income payments will be made by the Social Security Administration. But the program will be financed by general revenues—not by social security contributions

from workers and employers.

The aim of the new program is to provide supplemental payments in cases of need so that people 65 or over, or blind, or disabled will have a basic cash income of at least \$130 a month for one person and \$195 a month for a couple.

THIS DOESN'T mean that every eligible person or couple will be getting that much from the federal government every month. The amount of the federal payment any person gets will depend on how much other income he has. Also, states may add to the basic

Federal payment.

Eligibility for Federal payments will depend not only on the amount of income people have, but on the value of their assets.

If you're single—or married but not living with your husband or wife—you can own assets worth up to \$1500 and still get Federal payments.

A couple can own assets worth up to \$2250 and get payments. Not everything you own has to be counted toward your total assets, however.

A home of reasonable value will not be counted as an asset. Personal effects and household goods won't

count in most cases. Insurance policies or a car may not affect eligibility either, but it will depend on their value.

CERTAIN INCOME also will be disregarded in deciding on an application for supplemental security income. The first \$20 a month of income generally won't affect the federal payment at all.

In addition, people who are working part time should know that the first \$65 a month of earnings won't be included in counting their income and only half of the rest of their additional earnings will be counted.

Apart from earnings, other income above the first \$20 a month generally will reduce the federal payment. This includes social security checks, veterans payments, workmen's compensation, pensions, annuities, and gifts.

If you live in someone else's household, your basic federal payment will be reduced by one-third before other income that may affect your payment is deducted.

People who need more information to decide whether they might be eligible for the federal payments should call social security at 372-1910, or write to the office at 838 Louisa Street in Lansing. Or a friend or relative can make the call if the person in need isn't able.

It is also possible to contact social security in Lansing by telephone at no cost. People with St. Johns, Maple Rapids, Fowler, and Pawamo exchanges can call toll-free to social security in Lansing by dialing "0" and asking for Enterprise 6550.

EVEN THOUGH payments cannot start until January 1974, we're starting to take applications now so we can process them ahead of time and avoid delays that might occur if there's a rush of applications right at the end of the year," Seamon said.

TO THE EDITOR

J.O.Y. works

Dear Editor:

As our Job-O-Youth Program draws to a close, we would like to tell the people of the community how it went the first year.

We feel very successful for a FIRST. We knew we were going to make J.O.Y. work in St. Johns. We worked about 2,500 hours this summer, that wouldn't have been without this fine program.

We had a few problems but they were very small compared to what was gained. We bridged the gap between rural and city, between employer and employee, and between youth and the "older generation".

JOY appreciates all the community help given us. Advertising, money, supplies, and lots of time was donated to us this, our first year.

We the Executive Board, Office Staff, and the Working Force are enthusiastic, and strongly support JOY, and we're ready to go again next year.

WE NEED JOY!
Sincerely,
The Executive Board of JOY

DANCER'S IN ELSIE ARE HAVING AN END-OF-SUMMER CRAZY DAYS SALE THURSDAY, Aug. 23rd FROM 9 a.m. - 9 p.m.

HERE ARE JUST A FEW ITEMS AT SUPER LOW PRICES:



Over 300 Pair Of Our Famous Name Brand Dress & Sport

SLACKS

For Men & Boys Values To \$18⁰⁰ Or More

\$3⁸⁸

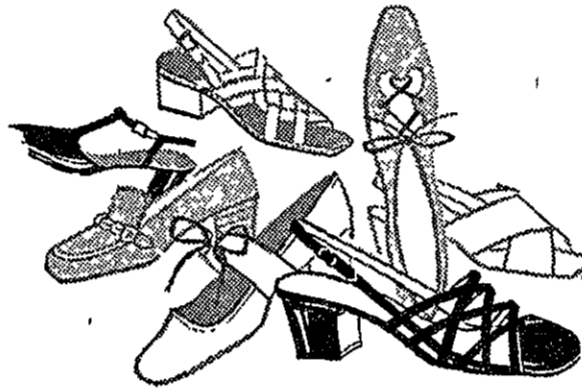

Women's Summer

SHOES

Values To \$11⁹⁹

Were Sale Priced At \$5⁹⁹

\$2⁹⁹

THURSDAY, AUGUST 23 ONLY

Mens & Boys SUMMER

JACKET

1/2 OFF



Good Selection

WOMEN'S SUMMER ITEMS

1/2 OFF or BELOW



PLUS MANY - MANY OTHER ITEMS AT COMPARABLE SAVINGS!!

DON'T FORGET - IT'S ONE DAY ONLY! THURSDAY - AUGUST 23 9 a.m. - 9 p.m. DON'T MISS THIS SALE



AND FOR YOU LATE SHOPPERS WE WILL ADD MORE ITEMS AT COMPARABLE SAVINGS AFTER 5 P.M.

AT DANCER'S IN ELSIE YOU CAN SAVE MONEY THE YEAR ROUND. ON OUR SPECIAL PROMOTIONS YOU SAVE EVEN MORE AND "CRAZY-DAY" IS JUST ONE OF THESE PROMOTIONS. — SHOP US OFTEN AND SEE HOW WE ARE HELPING YOU FIGHT INFLATION WITH GOOD 'OLE FASHIONED SERVICE AND PRICES.



SHOP & SAVE



ELSIE, MICHIGAN

SHOP & SAVE

"IT LOOKS AND FEELS LIKE REAL"

New England Barnboard Series

ONLY FROM **ABITIBI**

You've got to see it to believe it... a dramatic new hardboard paneling... with the depth, beauty and realism of historically treasured barn siding. The fitting background for any colonial or country decor... a rustic, weathered richness for any room.

WARNING:
If you see and touch this newest wall sensation from Abitibi, you'll want to own it.

CHAMBERLAIN BUILDING SUPPLY
218 E. Williams OVID 834-2300

Greenbush United Methodist Church to celebrate 75th anniversary

In the fall of 1849, 124 years ago, the Rev William Benson of Rochester Colony organized a class in a log school house near Jeffrey's hill, one-half mile south of Eureka. Members of this class were Nelson Daggett and wife, Nathan Spooner and wife, William Besley and wife, and James R. Carter. Nelson Daggett was appointed leader. This was the beginning of the Greenbush Church.

Among early ministers were the Rev Wilkinson, the Rev A.L. Crittenden and Elder Charles Smith of Essex Township.

Then, in 1855, another early religious organization was founded in what was known as the Wildcat Schoolhouse, and by 1860 it consisted of fifteen members. Elder Rose was one of the ministers there.

In 1865 the present Sherwood Schoolhouse was built to replace an old log structure, and in this building the 2 organizations united and held their services. The 1st minister here was the Rev Charles Chick, who lived in Maple Rapids, and preached there also.

Among the families who were regular attendants at these services were the Davies, Adams, Ellis, Goddard, Carter, Scott, Auten, Altman, Sherwood, Fleagle, Ingersoll, Hodgson, Gradt, Jolley, Besley, Loomis, Silvermail, Matthews, Blanchard, Marshall, Newman, and Mr Moizey, who was an exhorter.

The Rev Jason Cadwell was the pastor in this period from 1870 to 1872, and it was during his revival that many of the above families were brought into the church. It was also during this time, Nov 10, 1870 to be exact, that the Woman's Foreign Missionary Society was organized by Miss Rufison. There were 24 charter members in this organization. Of this group Mrs Jeanette Davies was the last surviving member.

At this early date, of course, there were no lesson leaves, but they made use of their Bibles, and of a wall chart from which lectures were given. James Carter was lecturer for several years. The pastor was paid entirely by free will offerings at this time, and so soon after the Civil War these were, by no means, large.

In 1877 the Keystone Grange of Greenbush built a 2-story hall a mile south of the schoolhouse on half an acre of ground given by R.C. Davies for a building site. It was built by a company of stockholders composed of Grange members. The Grange used the upper floor and allowed the Church to use the lower floor without paying rent. The members of the Church were glad to do this as it was a better location and much more convenient. The township elections were held here also.

In 1877 and 1878 the Rev E.J. Freeman, from Maple Rapids was pastor, and he was followed in 1879 and 1880 by the Rev S. Kitzmiller. Some of the members heard the Rev James Hamilton, then pastor of St Johns and desired that Greenbush be put on the St Johns charge.

This was done at the next conference, but the Rev Hamilton was made Presiding Elder and the Rev S.L. Hamilton was sent to St Johns in his place. Peter Fleagle was class leader at this time. Rev Hamilton was followed in turn by T.H. JACOBS, G.C. Draper, R.H. Bready, and A.D. Newton.

In 1888 the Rev T.A. Tallman was pastor at Maple Rapids. At conference he said he would return if Greenbush was put on the

Maple Rapids and Lowe charge. So ended a 10-year sojourn with St Johns.

After Rev Tallman came the Rev R.S. MacGregor, followed by Rev W.A. Taylor in 1890 and 1891, the Rev A.L. Burns in 1892, and the Rev A.O. Carmen in 1893. He remained 5 years and it was during his pastorate that 2 outstanding events took place. The 1st of these was a revival held in May 1895 with James Connolly as evangelist. It should be noted that this revival was held during the farmer's busiest season. The 2nd of these events was the building of the present church.

In 1896 the Church purchased for 50 dollars the title to the land where the Grange Hall stood. Then in 1897 they purchased, again for 50 dollars, an additional strip on the north side of the original plot. This was later used for the building of the 2nd horse shed. This plot was purchased from Mr and Mrs Edwin C. Stevens.

Before the purchase of the property there had been talk of the need for a real church building, and several plans were considered. The Grange Hall was sold to the township of Greenbush for 200 dollars and moved across the road to a site donated by Peter Fleagle.

At a special meeting a building committee was appointed which consisted of W.T. Bair, Marcus Jolley, F.S. Marshall, Peter Fleagle, John Bishop, and A.B. Dexter. F.S. Marshall was the treasurer. These men assumed the entire responsibility of financing the building of the church and pledged a thousand dollars as a start.

Meanwhile plans for a country church were made with the aid of Henry Hewitt, a Maple Rapids carpenter. Hewitt was employed to oversee the building of the church, a task for which he received \$1.50 per day. He turned his work over to Henry Mallory before the work was finished, and the building was completed under this supervision. The church was painted outside, and decorated inside as a donation of William Goddard. Several of the members bought a window bearing the name of the donor.

At the dedication enough money was pledged to clear the indebtedness on all church property. Including the horse sheds, the total cost of the building was nearly \$4000. The dedication took place on Aug 28, 1898, about 4 months after the laying of the cornerstone by Rev Carmen on May 3.

The dedicatory services were conducted by the Rev William M Puffer, D.D. and Bishop Nind of Lansing. The first pastor of the new church was A.T. Luther.

The Ladies Aid was organized in 1891 through the efforts of Mrs Fletta Andrus. The first meeting was held at the home of Mrs John Bishop. The following officers were elected: Mrs Lizzie Russell, president; Mrs Dora Bishop, secretary; Mrs N.K. Smith, treasurer.

The ministers following Rev Luther were E.C. Sinclair, J.E. Foote, E.E. Sprague, R.R. Atchison, who was the first pastor to drive an automobile, L.B. Kenyon and L.T. Robinson, who remained for 5 years. Extensive repair work was done. The attendance was about one hundred during his stay. A revival took place, after which many members were added to the church.

F.S. Kinney came in the fall of 1917 who stayed 2 years. Then the Rev. David

Reed and Robert S. Miller supplied for a time.

The church was originally equipped with 1 of the finest bells in the state. It could be heard for miles in good weather. Sometime in 1919 a change in tone was noticed. On investigation a crack in it was revealed, making it worthless. Whether this breaking of the bell occurred on Armistice Day in 1918 when it was rung feverishly or when the lightning struck the belfry is not known.

Churches that Greenbush has been on a circuit with are Maple Rapids, Lowe, St Johns, Duplain, Shepardsville, Bengal, Fowler, Price and Salem.

The Rev Birdsell came in 1920 and served for 2 years, followed by the Rev W.S. Phillips in 1922 who was on the charge for 7 years. Lawrence Ward of Essex, began work in 1928 and served 5 years.

Ministers serving the church since 1933 were Kenneth Griswold, Donald Winegar, A.L. Wagley, N.D. Chew, Robert L. Smith, Gerald Rubingh, William Noordyk, Herman F. Schwarzkopf, C. Harry Moon, J. Oliver Hall, Cornelius Oldenburg, Alden B. Burns, David Gorton, William Schaaf, Jr., Lloyd Hayes,

Richard K. Best, Rudolph Wittenbach, William Tate, Robert R. Boyer, Charles VanLente, Everett Love and Norman Wood.

On Aug 26, 1973 members will celebrate the 75th anniversary of the dedication of the church and 124 years of Methodism in the community.

Tourney Aug 27-28

ST. JOHNS -- The St Johns City Slowpitch Championship Playoffs will be Monday and Tuesday, Aug 27-28 in St Johns City Park.

Participating in the tournament will be the top 2 teams from each league at the end of regulation play. The 1st game will be Monday at 6:30 pm with the 2nd game scheduled for 8 pm. Another 6:30 pm game is

scheduled for Tuesday with the championship game set for 8 pm.

An added feature of the Tuesday night competition is the "Annual Battle of the Bottoms," pitting the 2 last place teams against each other.

The City League All-Star Game will be Wednesday night at 7 pm.



Greenbush Methodist Church

CAPITOL SAVINGS & LOAN

now offers

NEW, HIGHER INTEREST RATES

on savings accounts!

REGULAR
PASSBOOK SAVINGS
ACCOUNTS WITH
DAILY INTEREST

5 1/4 %
per year

Day in . . . Day out . . . Any day . . . Every day . . . Capitol Savings and Loan pays 5 1/4% daily interest on regular, insured passbook savings accounts from the date of deposit to date of withdrawal. Nobody pays a higher rate of interest on insured regular passbook savings accounts than we do.

GOLDEN
CERTIFICATE
SAVINGS
ACCOUNTS

6 1/2 %
per year

To qualify for this 6 1/2% one to two year certificate savings account, you simple keep \$1,000 or more on deposit for one year in this special certificate. Interest is paid and compounded quarterly to yield 6.66% annually. You can withdraw your money at any time with no advance notice, however, the withdrawn funds will lose 90 days' interest and, also, the interest on the withdrawn funds will be re-calculated from the original term of the certificate at the then current regular passbook interest rate. The amount left on deposit, provided it is \$1,000 or more, will continue to earn the 6 1/2% rate.
\$1,000 MINIMUM

FOUR-YEAR
CERTIFICATE
SAVINGS
ACCOUNTS

7 %
per year

A four-year certificate savings account may be opened at any time with \$5,000 or more . . . no special "even" figure is needed. Interest is paid and compounded quarterly to yield 7.19% annually. You can withdraw your money at any time, however, in accordance with federal regulations the withdrawn funds will lose 90 days' interest and, also, the interest on the withdrawn funds will be re-calculated from the original term of the certificate at the then current regular passbook interest rate. The amount left on deposit, provided it is \$5,000 or more, will continue at the 7% rate.
\$5,000 MINIMUM

*The penalties charged on withdrawn funds are set by federal regulations and are the same for ALL financial institutions.

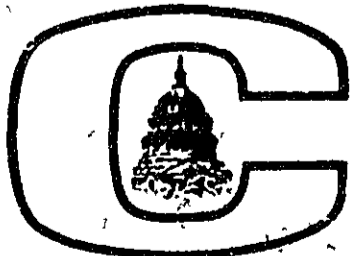

Home Office: 112 E. Allegan, Lansing
INCORPORATED 1890 • LANSING, MICHIGAN • MEMBER FEDERAL HOME LOAN BANK SYSTEM

CAPITOL SAVINGS & LOAN

222 N. CLINTON AVE. — ST. JOHNS



elul ROMA LIQUOR
OPEN TO SERVE YOU
WEEKDAYS 11 AM TO 12 PM
FRIDAYS & SATURDAYS
11 AM TO 2 AM
OPEN AT 2 ON SUNDAYS
LIQUOR FOOD DANCING
LIVE MUSIC

AT ROUND LAKE

COVER CHARGE WITH LIVE MUSIC

AUG. 23 ANNUAL SWEET CORN FEAST
Bring dish to pass. We will furnish corn, bread, rolls & goodies. "Make New Friends."

AUG. 25 CROOKS & CO.
Featuring Jimmie Gilligan
COVER CHARGE

OVID-ELSIE



Approve teacher contract for Ovid-Elsie Schools

The Master Agreement between the Ovid-Elsie Area Schools and the Ovid-Elsie Education Assn was ratified by the O-E School Board as expected at their regular meeting Aug 13. The Master Agreement between the school system and Ovid-Elsie Custodians was also ratified.

Upon the recommendation of Superintendent Don Kenney, contracts were

approved for J Michael Cole, high school business teacher; Dennis K Sellers, high school agriculture; Mary A Lewis, high school English; Margaret A Militello, 5th grade at E E Knight; Cynthia S Follett, 3d grade, E E Knight; and Daniel G O'Boyle, 6th grade, Elsie Junior High School.

Also receiving contracts were Cleo S Hensley, remedial reading, North Ovid; Andrea C Judd, 2d grade, North Ovid; and Jan E Fuhlbeuge, Resource Room, East Ovid.

A letter was read from the Rev Robert Prange of Grove Bible Church stating their intention to start an elementary school this fall. The board voted to allow transportation of children in the Ovid-Elsie school district to their school by utilizing presently established routes.

A letter of resignation was received from Thomas Bartol, teacher at Ovid-Elsie High School. His resignation was accepted with regrets by the board.

A letter was also received from the Dept of Education stating that a tentative allocation for the 1973-74 school year amounting to \$33,036 for financial assistance in the elementary reading program would be given the district.

A short discussion was held regarding problems of the Ovid Junior High School gymnasium floor. Difficulty is being encountered in obtaining replacement wood for the floor, so the project is still being worked on.

The board was invited to review the revamped locker rooms in each junior high school building.

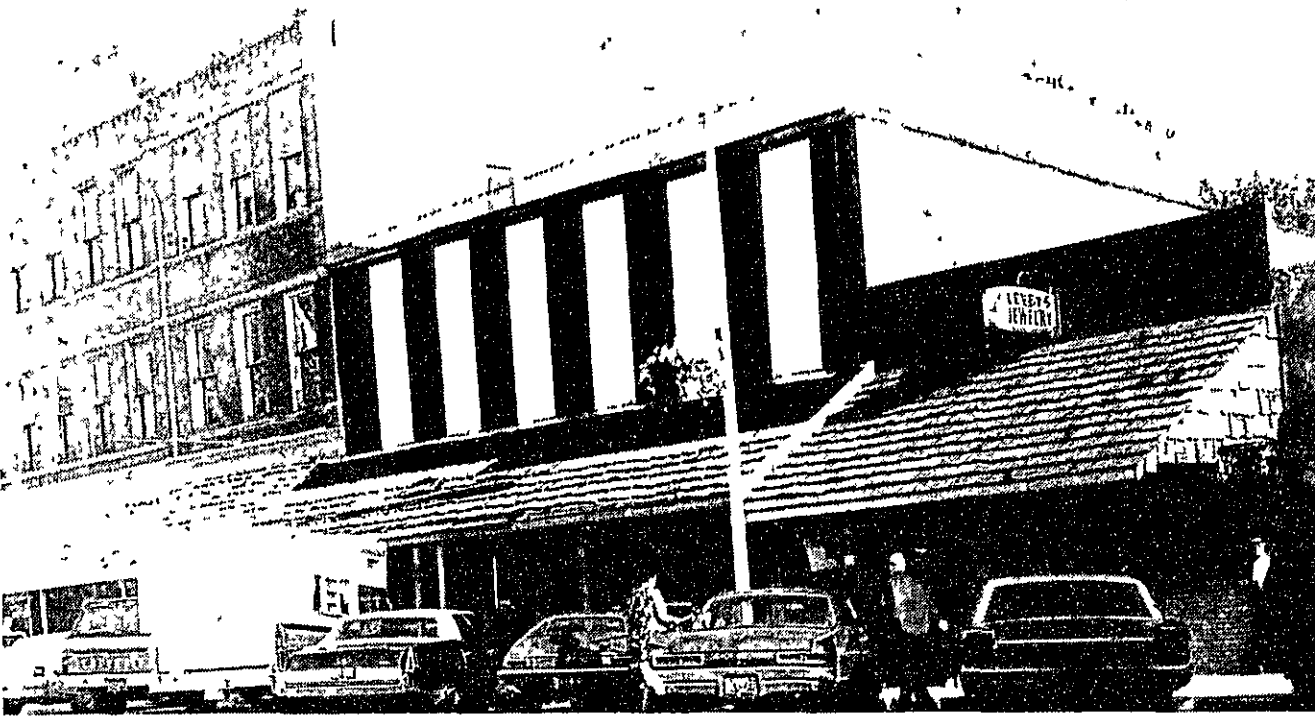

DOWNTOWN ELSIE TAKES ON NEW LOOK AS STORE OWNERS REDECORATE WITH NEW STORE FRONTS.

Former Ovid-Elsie editor in Who's Who

Mrs George (Donna) Wilbur of Lansing, a former Ovid resident, has been listed in the 1974-75 edition of "Who's Who of American Women."

Now an information specialist for the Michigan Farm Bureau, she was nominated for the honor in the editor-publisher category. She and her husband published the weekly Ovid-Elsie Banner from 1968 through 1971.

During that period, they were recognized by the Michigan Education Association 3 consecutive years for outstanding coverage of education, and received an award of excellence from the Michigan Press Association for best editorial page. Mrs Wilbur has also won various other awards for her writings.

"Who's Who of American Women" is a biographical record of individuals who have demonstrated outstanding achievement in their own field of endeavor and contributed significantly to the betterment of contemporary society."

-30-

TOM'S WESTERN STORE
 OVID, MICHIGAN 48866
 HORSE AND PONY EQUIPMENT
 SQUARE DANCE & WESTERN CLOTHING
 9:00 to 5:30 Mon - Thu
 9:00 to 9:00 Sat 9:00 to 5:30
 (517) 834-5446

WHAT A KNOCK OUT OF A PRICE!

Heavyweight Values! Knockout Prices!

See US For Your New **CHEVROLET Passenger Car CHEVROLET Truck.**

V.L. MOORE & SON CHEVROLET

132 N. Main OVID 834-2213

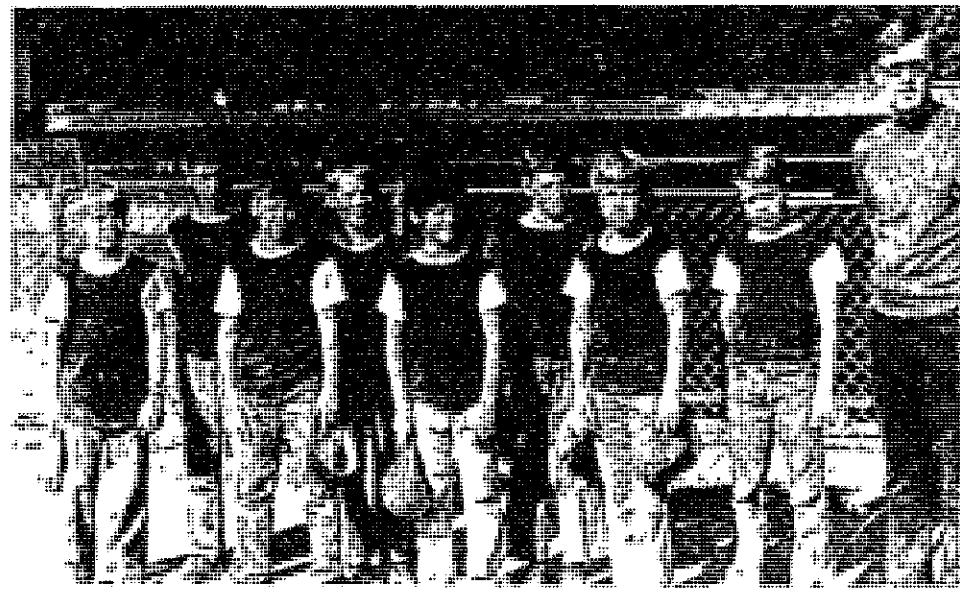

Shown above are the champs of the Elsie Pee-Wee League. (Cook's Soft Water team) Back row (left to right) Jerome Fogarty, Angelo Fogarty, Rich Taylor, Chris Jones, Manager Larry Ott. Front row, Mike Ott, Tom Galecka, Frank Ortiz, Scott Miller. Missing from picture - Scott Bates, Kevin Baese, Don Gilbert, Tim Salyer, Ass't. Manager Jerry Winans.

(Photo courtesy of Elsie Advertiser)



Members of the Championship Bannister Babe Ruth League team are (front, from left) Rich Betz, Jack Bashore, Larry Stammersky and Ray Trevino, (rear, from left) Manager Mick Stammersky, Jim Quine, Gary Bernath, Pete Salyer and Bob Moore. Not shown are Kirk Baese, Gary Selfridge, Dan Wilkins, Perry Salyer, Ted Geiger and Dave Cerny.

Bannister takes Babe Ruth crown

The Clinton-Gratiot Babe Ruth league ended its season last Saturday with a 6-team single elimination tournament. The winner was the Bannister team for the 2d time in 2 years. Bannister defeated Perrinton 8-2 Monday and then came back Wednesday to beat Ovid 5-3 with the finale Saturday with Bannister defeating runner-up Ashley 11-2.

Bannister finished the season with an overall record of 11 wins and 3 losses. Members of the team, are Rich-Betz, Jack Bashore, Larry Stammersky, Ray Trevino, Manager, Mick Stammersky, Jim Quine, Gary Bernath, Pete Salyer and Bob Moore, Kirk Baese, Gary Selfridge, Dan Wilkins, Perry Salyer, Ted Geiger and Dave Cerny.

MIRACLE MAN
 Today they call a man an extremist just because he's able to make both ends meet.

MID-SUMMER CLEARANCE

All Wheel Horse Equipment
 In Stock
 7-8-10-12-16
 Horse Power
 LAWN & GARDEN TRACTORS
VINCE ACKLES ELSIE
 254 E. Main 862-4482

Change your name before it's too late. We're going to press!

Breytspraak John Jack
 1864 Lake End Dr.....864-0299

If you've changed your name, or want to add a new listing for a son or daughter, call our business office today. One call to us now can mean many important calls from your friends next year.

Yellow Pages
GENERAL TELEPHONE

MORTGAGE PAYMENT PROTECTION REPLACEMENT INCOME INSURANCE

We offer a combination of mortgage insurance which will pay off the mortgage if you die and

which will make the payments if you are sick or injured and can't work.

This fine coverage costs less than you think!

A father at age 25 can protect a \$25,000, 30-year mortgage on his home for just over \$10.00 per month-a small amount for family peace of mind.

For Complete Facts See Or Call **WILLIAM F. HOLLEY**
Carter - Melvin INSURANCE AGENCY
 Your Independent Insurance Agency
 122 W. Main, Elsie
 Phone 862-4227
 Residence Phone 224-7580

OUT THEY GO!

YEAR-END MODEL CLEARANCE

There is NO TIME Like Right Now During Our 1973 Model Close-Out Sale To Get That New Ford You And The Family Have Been Dreaming About.

Stop in and see us NOW!
DICK HALLEAD

FORD

ELSIE PHONE 862-4253
 Sales Department open Monday & Friday evenings.
 Service Department open Monday evenings.

INDUSTRIAL COMMERCIAL RESIDENTIAL REAL ESTATE

NEW HOMES
 No Down Payment
 7 1/4% Financing

MODELS;
 LOCATED IN OVID AND ON JUDDVILLE ROAD

WE HAVE NEW HOMES AVAILABLE FOR THE FARMERS HOME ADMINISTRATION AND FHA PROGRAMS.

For Sale or Rent, Store Bldg., in center of business district, immediate possession.

230 E. Front St. 3 bedroom, 2 lots, new gas furnace, completely remodeled. No down payment. V.A. Financing, Available.

5-acres-North Meridian Rd. Excellent home building site.

10 acre parcel with creek thru it. Terms.

3 - New Ranch Homes in Ovid, 3 bedroom, full basement, carpeting.

424 N. Park - 4 bedroom, full basement, 2 car garage, corner lot, oil furnace, new roof, carpeting, range, refig, curtains and drapes included.

247 E. First St. Immaculate older 3-bedroom home, on nicely landscaped corner lot, completely remodeled including new furnace, has large two car garage, carpeting, much closet space, 2 full baths, utility room, den and many other extras.

3710 Balcom Rd. 4-bedroom remodeled house on 14 acres, all tillable, 36x60 barn - Ovid-Elsie schools.

OVID SERVICE AGENCY, Inc.
 104 North Main St.
 Gilbert O. Bovan - Broker
 Phone 834-2288
 Sales Personnel: Tony Sincropl
 834-5049

PROPERTIES ARE MOVING IN THE OVID AREA... If You're considering selling, SEE US FOR FAST ACTION!



Elsie

MRS. NEVA KEYS
Ph. 862-4301

Mrs Dorothy Kaspar and Mrs Margaret Edwards of St Johns, Donald Willard of Ovid and Mr and Mrs S.J. Keys of Elsie spent the weekend touring West Michigan from the lake area of Greenville and Newaygo to Hart and Pentwater where they followed Lake Michigan shoreline through Ludington, Manistee and the Crystal Lake region.

The trip was a special surprise to Mrs Kaspar whose birthday will be August 27. They spent the night in Traverse City and the next morning drove along the Grand Traverse Bay to Northport, Sutton's Bay and Lake Leelanau.

The weather was perfect for the colorful sailboat and the boats of fishermen and water skiers. They also rode through the Williamsburg area where the recent caverns caused by oil well drilling operations made news headlines by the damage caused.

Their return trip home covered the lake areas south of Kalkaska with dinner that evening at the Burning Oaks Country Club located between Higgins and Houghton Lakes, after 18 holes of golf.

Mr and Mrs Charles Crell of Elsie and Mr and Mrs Ray Patrick of Jackson spent four days on a trip to Minneapolis, Minn to attend a F.R.A. convention of retired Navy and Marine Coast Guards.

The ladies enjoyed a visit to the Betty Crocker Testing Kitchens.

Mr and Mrs Jerry Missi of Largo, Florida were all-day guests of Mr and Mrs Don Huguélet Wednesday. Mrs Missi is the former Pat Galehouse of Elsie and this was her husband's first trip through Michigan. They planned to visit her brother, John Baker in Wisconsin before returning to Florida.

Mrs Grace Fizzell has moved into her recently purchased trailer home at 218 Second St, Elsie, formerly owned by Mrs Betty Capen.

Julie Olney 19, a Gold Medal winner in the javelin throw at the recent World Deaf Olympics, has returned to her home in Swartz Creek after an eventful summer as a member of the US Deaf Olympic track team. Julie is the daughter of Mr and Mrs Harold Olney (Sharon Martin) former Elsie residents.

The World Deaf Olympics were held the last of July in Malmö, Sweden, with athletes from many nations taking part in the competitions. The United States team won first place; followed by Russia in second, and West Germany in third. Julie was one of two girls who won gold medals on the US team.

For several weeks before going to Sweden, Julie trained at Washington, D.C. While there during a sanctioned meet at the University of Maryland, she set a new world's record in the javelin with a throw of 142 feet and received another medal.

Last summer Julie was selected for the US team by winning the finals at Morgantown, N.C. where she established a new American record. She is a member of the Flint Athletic Club and has won many honors with them in meets throughout the Midwest and Canada.

Julie graduated with honors last Spring from the Michigan School for the Deaf at Flint, and plans to enter college at Springfield, Missouri, this fall, as a physical education major.

Julie is the granddaughter of Mr and Mrs Robert D Martin of Elsie and Mr and Mrs George Olney of Brooksville, Florida, now spending the summer in Michigan.

Mrs John Hall is returning home from the Owosso Memorial Hospital where she has been under treatment the past week.

Mrs Dora Lowrey had the misfortune to fall recently and was taken to the Owosso Memorial Hospital where x-rays were taken. She will

remain there for several days.

Mrs Wilma Miller underwent surgery this week at the Owosso Memorial Hospital.

Orlo Mead, Jr., is recovering from surgery at the Carson City Hospital where he has been the past two weeks.

Bannister

Members of the Chippewa Chippers 4-H Club and the Busy Green Clover 4-H Club exhibited their various items at the Gratiot County Youth Fair this past week. Several members participated in the pig scramble and Todd Heimberger of the Chippewas caught his pig. The fair began Monday with each exhibitor bringing in their items. Then each day there was a special event, judging, horseshow, pig scramble and many others.

The Bannister United Methodist Church and Sunday School held their annual picnic at the poolside of Mr and Mrs Dale Randolph recently. A potluck lunch was served followed by an afternoon of swimming and enjoying the sun.

Terrell, Mr and Mrs Elmer Leydorf, Mrs Brad Mitchell and Mrs Robert Valentine, Jim Valentine and Todd Moore are attending senior high camp at Lake Louise this week.

The Bannister United Methodist Youth will sponsor their annual Homemade Ice Cream Social on Aug 24 at the church. It will feature homemade ice cream, sloppy joes, cake and pie. This is a freewill offering meal and serving will be from 5:30 until 8 pm. The Bannister Women's

Society of Christian Service met Wednesday evening in Wesley Center where they were instructed to take a Blind Walk with a partner around the church. This was an experience showing faith in another person. Mrs Robert Valentine then gave the Lesson on "Power in Praise". Mrs Ivan Hofferbert explained the worship setting and gave the devotions.

Mrs Kenneth Swanson conducted the business meeting. The \$25.00 missionary money was to

be distributed in the area as part of Key 73. Committee reports were given and members were reminded that the UMYF will hold their annual Ice Cream Social on August 24 with serving beginning at 5:30. A free offering will be taken and the public is invited to attend. Refreshments for the evening were served by Mrs Margaret Coon, Mrs Wayne Peck and Mrs Floyd Glowney.

CENTRAL NATIONAL BANK

Now Offering New HIGHER INTEREST On Your Savings

5 1/2 %

ON OUR V.I.P. TIME PASSBOOK SAVINGS PLAN. YOU MAY OPEN ONE FOR AS LITTLE AS \$100.

6 %

ON OUR SAVINGS CERTIFICATES WITH A MATURITY OF ONE, ONE-AND-A-HALF OR TWO YEARS IN AMOUNTS OF \$500 OR MORE.

6 1/2 %

ON OUR SAVINGS CERTIFICATES WITH A MATURITY OF TWO-AND-A-HALF, THREE OR THREE-AND-A-HALF YEARS IN AMOUNTS OF \$1,000 OR MORE.

7 %

ON OUR SAVINGS CERTIFICATES WITH A MATURITY OF FOUR YEARS IN AMOUNTS OF \$5,000 OR MORE.



SERVING THE CLINTON AREA FROM 4 CONVENIENT LOCATIONS

St. Johns MAIN OFFICE 201 E. Walker
Ovid BRANCH OFFICE
Pewamo BRANCH OFFICE
St. Johns BRANCH OFFICE South gate Plaza So. U.S. 27

Shepardsville News

MRS. JOHN SPLNCER
Ph. 834-2617



Barbara Rensch was guest of honor at a bridal shower at the Shepardsville United Methodist Church on Wednesday evening Aug 15. The shower was hosted by Mrs Lee Swender, Mrs Charles Swender, Mrs Lester Becker, Mrs Francis Hall, Mrs Ray Jones and Mrs Marian Walker. There were 25 guests present from St Johns, Rochester Colony, and the surrounding area.

Two games were played with prizes going to Mrs Robert Coleman and Mrs Karl Smith.

The gift table was decorated in pink with a small bouquet of miniature roses. The refreshment table was centered with a white cake decorated with pink roses. Punch, nuts and mints were served along with the cake.

Miss Rensch was assisted in opening her many useful gifts by her mother and mother-in-law to be, her mother registering the gifts and her mother-in-law to be making the ribbon bouquet.

Miss Rensch has an altar date on August 25 with Charles Walker, Jr.

Lee Ormsby was guest speaker at the Sunday morning worship service at both the Shepardsville and Price Churches.

Mr and Mrs Ralph Baker have returned home after spending a few days in the northern part of the lower peninsula.

Miss Juva Wilkins was guest organist at the Shepardsville United Methodist Church on Sunday, August 5.

Rev and Mrs Darold Boyd and children are on vacation for the next two weeks.

There will be a bridal shower sponsored by the ladies of the Shepardsville Church for Miss Barbara Rensch on August 15. Miss Rensch has an altar date in the very near future with Charles Walker, Jr. There will be no other invitations sent to the church ladies. The time is 7:30.

Speakers for the next two Sundays at both the Price and Shepardsville Church are on August 12, Mrs Walker and Mrs Phinney and on August 19 Rev Chauncey Green and Mr Clare Alderman.

Carland News

Lewis Walling, father of Mrs Leo Deming of Carland, Mrs Donald M Wood of Owosso, and Mrs Thomas Winkler of Ovid, celebrated his 82nd birthday, Sunday at McCurdy Park in Corunna.

A picnic dinner was held in Mr Walling's honor with 25 relatives attending from St Johns, Grand Ledge, Owosso, Ovid, Carland, and Elsie. He was presented with a birthday cake, decorated with "We love you, Dad & G-pa" and many gifts, cards, and well wishes.

The group attended the dedication of the foot-bridge at the park in the afternoon and its ceremonies.

Lori and Lisa Stinson, daughters of Mr and Mrs Grant Stinson both won blue ribbons with their 4-H sewing

projects at the Shiawassee County Fair.

Mr and Mrs Clyde Gilbert and sons spent a week of their vacation at Interlochen, camping out, canoeing, swimming, and enjoying all other summer fun there.

Mrs Cyril Simpson has returned to her home in Carland, from a tour of the Hawaiian Islands including Oahu, Maui, and Hawaii. The tour was sponsored by Central Michigan University.

Mr and Mrs Robert Hartwick and family of Washington have been visiting the Nethaway families this week in and near Carland. Mrs Hartwick is the former Ann Nethaway. Mr Hartwick's mother is a patient in Sparrow Hospital in Lansing.

4-H youth win Fair honors



Delores Curtis, Victor Club,
- Decorated Litter Barrels



Monica Heiler - Rabbit Showmanship



Don Washburn - Photography



Helen Blakely - Flower arranging



Rosette winners in the Clinton County 4-H Fair are Helen Rose Blakely, Jeanne Striz, Lisa Foy, Cheryl Conklin, Linda Wesseler, Debbie Thelen, Kris Rees and Anne Slate.

Legal News

PUBLICATION OF NOTICE OF HEARING
State of Michigan, The Probate Court for the County of Clinton

Estate of ELIZABETH CHRYSLER GOOD-KNECHT, deceased File No. 19060.

TAKE NOTICE: On October 31, 1973, at 11:00 A.M., in the Probate Courtroom, Courthouse, St. Johns, Michigan, before the Hon. TIMOTHY M. GREEN,

Judge of Probate, a hearing will be held to re-affirm the appointment of heirs; and all creditors must file sworn statements of claim with Court, sending copy to

Michael W. Goodknecht, Administrator, of 119 W. Clinton, Ovid, Michigan.

Dated: August 9, 1973.
Michael W. Goodknecht
Petitioner
119 W. Clinton
Ovid, Michigan

Attorney for Petitioner:
Lewis D. Benson (023204)
203 "Owosso" Savings Bank Bldg.
Owosso, Mich. 48867
Phone 725-2117 16-3



Marilyn Gorman - Pony fitting & showmanship

PUBLIC AUCTION

LAINGSBURG FARM SERVICE, 208 RAILROAD ST., LAINGSBURG, MI.
Located 7 miles North off M-78 turn on Woodbury Rd. or 7 miles South of Ovid, or, 15 miles Northeast of Lansing

TUESDAY, AUGUST 28, 1973

Starting at 10 A.M.

COMPLETE GRAIN AND FEED ELEVATOR

American grain dryer, 750 bu. per hour capacity,
4 Butler 16,000 bu. each steel bins, 60 ft. elevator leg & screw, belt drive. Offered as a unit subject to individual bid
800 bu. per hour fanning mill w/10 H.P. motor
2,000 bu. holding bin
3-40 ft. legs for grain inside w/motor
350 bu. per hour fanning mill w/7 H.P. motor
Bauer 60 H.P. fanning mill
4,500 gal. molasses tank
2-160 bu. feed mixers; small feed mixers
30 H.P. hammer mill; 3 platform scales
3 cob crushers; cob bin
2 elevator legs, 40 & 80 ft.
2 top elevator screws
2 shaker type receiver pits
3 augers, 21-16 & 6 ft.
Transport auger w/8 H.P. gas engine
Crippen box car loader
Triumph corn sheller
Fairbanks-Morse 20 ton truck scale w/imprinter; 2 1/2 ton truck hoist
New compressor motor in box
350 gal. gas tank w/stand
20 gates, all sizes
6 rolls of new snow fence
15 rolls woven wire fence
Large safe; Paymaster check protector
2 desks; 2 counters; file cabinet

Small elec. calculator; office chairs
Coca-Cola machine; 2 steel shelving units
2 gas furnaces; quantity Tingley boots

FEEDS-SEEDS-ETC.

Quantity of cattle sprays; horse sprays; insect sprays & garden dusts
Hand scoops; aluminum scoop shovels
Rabbit pellets; dog & cat food
Quantity of chicken, dairy & hog feeds:
Mineral TM & white salt
Bonemeal; rolled oats; horse feed; oyster shells; calcium carbonate
dicalcium phosphate; Barn Bright
Rock salt for water softeners, pellets & brick; 9 bags fine grit
10 gals. Mist-o-Matic liquid
7 cases of Kleen-Korn spray
20 lbs. of Dowpon
1 barrel ice melter
1 bag Piper Sudan grass
40 lb. Tenoran; 20 lbs. Sinazine
Large quantity mortar & Redi-Mix
Quantity chimney block, 8x8 & 8x12
Quantity corner blocks; Bell tile
Plastic & clay tile, quantity fly blocks
Approx. 60 cedar 10 ft. posts
Steels fence posts (10)

TRUCK & MISC. ITEMS

1971 GMC s/n CE F116 197 one-ton stake rack truck; 5-ton tandem fertilizer spreader; Jacobsen 10 H.P. garden tractor w/hydrostatic drive, nearly new. Quantity of tools, fuses, electrical boxes and wire. Quantity of Rawleigh products; other items.

Terms: Cash or Check Sale Day. Will offer mill and business in bulk bid subject to piecemeal bids. Physical structure is on leased railroad land approx. \$600 per year lease. Inspection week of sale.

Sale principals not responsible for accidents.

LAINGSBURG FARM SERVICE

Ralph Iocco-Owner

WAYNE G. FEIGHNER AUCTION SERVICE AUCTIONEERS

MASON, MICH.

PHONE 676-5028

Attends annual banking school

MADISON, WISC--A St Johns resident recently participated in commencement exercises at the University of Wisconsin, having completed the annual 2-week session of the Graduate School of Banking. Representing Clinton National Bank and Trust was Gayle L. Desprez.



Victor - 4-H winning float

MINI-PRINT

by PRINTCO

120 E. Walker St.
St. Johns, Michigan

Across from the St. Johns City Hall

PRICE LIST

Following price list applies to flat sheet work done from your copy on 20 lb. white bond in black ink:

Quantity	8 1/2 x 11		8 1/2 x 14	
	one side	two sides	one side	two sides
50.....	3.90.....	5.75.....	4.60.....	6.70.....
100.....	4.75.....	6.80.....	5.30.....	7.70.....
200.....	5.60.....	8.15.....	6.30.....	9.20.....
300.....	6.45.....	9.20.....	7.20.....	10.70.....
400.....	7.25.....	10.10.....	8.10.....	11.50.....
500.....	8.05.....	11.00.....	9.00.....	12.75.....
600.....	8.85.....	11.90.....	9.90.....	14.00.....
700.....	9.65.....	12.80.....	10.80.....	15.25.....
800.....	10.45.....	13.70.....	11.70.....	16.50.....
900.....	11.25.....	14.60.....	12.60.....	17.75.....
1000.....	12.05.....	15.50.....	13.50.....	19.00.....
Add'l M's	7.00	10.00	9.00	11.00

*Colored bonds are an additional 10¢ per hundred copies.
*Colored inks are an additional 10¢ per hundred plus \$2.00 set up.

PHONE 224-6781

County Commissioner proceedings

Tuesday July 3, 1973

The Clinton County Board of Commissioners met Tuesday July 3, 1973 at 9:00 A.M. Prayer was offered by Maurice Gove. A pledge of allegiance was given to the flag. Roll was called and a quorum reported. Present were Derrill Shinabery, William Hufnagel, Harold Martin, Maurice Gove, Donald Gilson, Duane Chamberlain, Roger Overway, Dyle Henning, Alta Reed, Virginia Zeeb and Gerald Shepard.

Minutes of the June 19, 1973 meeting were presented. Corrections were made. Henning moved, supported by Hufnagel, to approve the minutes as corrected. Voted and carried.

Communications:
Chairman Shinabery appointed the Board as a committee of the whole to attend the Annual meeting of M.A.C. to be held at Boyne Mountain August 13th, 14th & 15th.

1. National Association of Counties have released a National Survey of the appointed administrator in County Government. Zeeb moved, supported by Gilson, to purchase three copies at a member cost of \$3.00 each. Voted and carried.

2. Lansing Metropolitan Development Authority requests permission to appear before the Board or Committee to explain their organization functions. Chairman instructed the clerk to invite them to appear at the next regular meeting.

3. An invitation from C.A.P.A.C.O.G. asking Clinton County to become a member of that organization was read and discussed.

The appointment of a person to work with T.C.R.P.C. on the securing of grants was also discussed. Gilson moved, supported by Henning, that the Chairman be authorized to appoint someone to investigate the securing of Federal & State Grants to assist in the implementation of some of the County's most pressing needs. Voted and carried.

Shepard moved, supported by Reed, to authorize Chairman Shinabery to attend the N.A.C.O. conference to be held at Dallas, Texas on July 22 thru 25th. Voted and carried.

The Board recessed for committee meetings at 10:00 A.M.

Upon resuming session, Commissioner Gove read and he moved, supported by Henning, to adopt the following resolution. Voted and carried.

RESOLUTION

WHEREAS, members of the Clinton County Board of Commissioners are concerned with the new code of rules and regulations being compiled by the Michigan Department of Corrections for operation of Michigan jails, lock-ups, and security camps; and

WHEREAS, some changes have been made to relieve small counties of excessive construction costs if forced to build a new jail; but

WHEREAS, there still remain in the proposed code, items of excessive and needless cost for space in jails where the average occupancy is small (less than fifty);

We seriously question the need in a small jail for separate areas for dining, activity and recreation. It would seem that such areas could be interchangeable to reduce construction costs. Likewise, we see no reason for a separate dining area for staff members in a small jail, and the need to air-condition the entire facility.

WHEREAS, this Board objects to these and other excessive requirements.

NOW, THEREFORE, BE IT RESOLVED, that the Clinton County Board of Commissioners does hereby petition its representatives in the Michigan Legislature to do all within their power to reject the proposed code as it now exists in the hands of the Joint Legislative Committee. Should this code not be revised to bring relief for smaller counties, we ask our Legislators to provide funds for the excessive requirements.

Gove presented a request by Drain Commissioner Dale Chapman for permission for himself and for Arden Pierson to attend the Annual Drain Commission Conference at Traverse City, August 8th, 9th & 10th. Henning moved, supported by Gilson, to approve the request. Voted and carried. County Commissioners are also invited to attend the meeting. Shepard moved, supported by Reed, to also approve members of the County Commissioners attending the Annual Drain Commissioners meeting if they wish to do so. Voted and carried.

Henning moved, supported by Hufnagel, to concur with the resolution from Gogebic County (pollution of Lake Superior by Reserve Mining Company) and to so inform the Governor and our State Representatives. Voted and carried.

Sheriff Hufnagel appeared and presented James Moline. He explained the M-R-7 moving Radar System, which is an improved system for use by Sheriff Patrol Cars. The cost is \$2185.00 per unit. Discussion followed. They are suggesting two (2) units at a purchase price of \$2075.75 each or a lease @ \$68.04 each per month. Hufnagel moved, supported by Zeeb, to lease two (2) units for a trial period of three months. On a roll call vote those voting aye were: Shinabery, Hufnagel, Martin, Gove, Gilson, Overway, Henning, Reed, Zeeb and Shepard. Nay: Chamberlain, 10 aye 1 nay, motion carried.

Chairman Shinabery presented an opinion by the Prosecuting Attorney regarding the county's liability on ambulance services rendered on accidents occurring in Clinton County. Commissioner Shepard presented a letter which is being sent to ambulance companies outlining recommended procedures which should be followed in attempting to collect for services rendered.

The Board recessed for lunch at 12 noon.

P.M. SESSION

On again being called to order, Arnold Minarik, presented the action taken by and the recommendations of the Clinton County Zoning Commission at their May 17, 1973 meeting.

Item #1 Watertown Township (Industrial Maintenance) (Tabled Item)
Application for a Special Use Permit to allow for open storage on the following described parcel of land:

Com at the cen of Sec 34, T5N-R3W th N 160 rds to the N In of sd Sec; th E alg sd N In 70 rds; & with this pt as a pl of beg E 50 rd S & 86 rds to the hwy th foll sd hwy a little N of W 53 rds th N to the pl of beg being pt of NE 1/4 of Sec 34 T5N-R3W Watertown Township, Clinton County, Michigan.

Henning moved, supported by Hufnagel, to concur with the Zoning Commission recommendations and grant a Special Use Permit. Voted and carried.

Item #2 Bath Township (Darrell Brown Agency)
An application for Special Use Permit for a church site on the following described parcel of land:

That part of SW 1/4 of SE 1/4 lying NW of Hwy Sec 32 T5N-R1W exc com at SW cor thereof th N alg N&S 1/4 line 1330 ft m/1 to N in thereof the E alg sd In 297' th S// to N&S 1/4 in 1280.5 ft m/1 th E// to S In of sd Sec 357 ft to cen of Park Lake Rd, th SW'ly alg cen of sd rd 49.5 ft to S sec in th W alg sec in 926 ft to beginning.

Chamberlain moved, supported by Henning, to concur with the request and grant a Special Use Permit. Voted and carried.

Item #3 AMENDMENTS
(A) Referred back to the Land Use Committee.
(B) Referred back to the Land Use Committee.
(C) To require a Special Use Permit for non-commercial kennels in the R-1A district (Section 5.8, (7) to read: Except when a kennel license has been granted and special use permit issued by the Clinton County Zoning Commission, household pets may not—
Henning moved, supported by Gove, to approve Item C. Voted and carried.

Item IV TABLED AMENDMENTS

(A) Amend Chapter 9 to read as follows:
CHAPTER 9 JUNK

Sec. 9.1
No person shall store, place, abandon or permit to be stored, placed, abandoned, or allow to remain, in any district, a dismantled, partially dismantled, unlicensed, or inoperable motor vehicles, junk, rubbish or litter upon any premises, except as provided in Sec. 5.59, or in the case of motor vehicles unless confined in a wholly-enclosed structure.

Sec. 9.2
No person shall store, place, abandon or permit to be stored, placed, abandoned, or allow to remain, in any district, wrecked or inoperable farm machinery, unless hidden from the view of the general public or screened by a screen approved by the Zoning Administrator.

Sec. 9.3
Violations of this chapter shall be punishable as provided in Sec. 3.9.

Shepard moved, supported by Zeeb, to adopt the amendments Sec. 9.1, 9.2 & 9.3. Voted and carried.

The following is also included in the above motion:

(B) Chapter 11 DEFINITIONS
Sec. 11:2 (add a new definition)

(50a) "Junk" shall be considered to be miscellaneous dry solid waste material resulting from housekeeping, mercantile and manufacturing enterprises and offices, including but not limited to scrap metals, rubber and paper; abandoned, wrecked, unlicensed and inoperable automobiles and motor vehicles; rags, bottles, tin cans, and comparable items.

Shepard moved, supported by Gilson, to adopt the Definition. Voted and carried.

Dale Chapman recommends that Clinton County Drain Engineer be named as County Plat Surveyor, to review proposed plats. Overway moved, supported by Shepard, that Clinton County Drain Engineer be named as County Plat Surveyor to review proposed County Plats. Voted and carried. Chairman Shinabery instructed the clerk to check on rates presently being charged by other comparable counties for this service.

Chamberlain reports his committee met with the newly appointed Agricultural Extension Director, James Pelham, of Barry County. He will be coming to Clinton County about August 1, 1973.

Reed moved supported by Hufnagel, to take from the table the request by DeWitt Township to take over the operation of the D.P.W. Sewage Disposal System. Voted and carried. Discussion followed. On a roll call vote those voting aye were: Reed and Zeeb. Nay were: Shinabery, Hufnagel, Martin, Gove, Gilson, Chamberlain, Overway, Henning and Shepard. 2 ayes, 9 nays. Motion defeated.

Shepard reported for the finance committee.

1. A motion by Henning, seconded by Gilson, that Clinton County participate in the Metro Narcotic Squad by appropriating \$2,000.00 for the remainder of 1973 to the Metro Squad and \$500.00 to line item #959 in the Sheriff's budget (Special Fund Metro Squad) from Federal revenue sharing monies. Voted and carried.

2. Reed made a motion to transfer to County Commissioners Budget \$2,200.00 out of Contingency Fund to line item #837, memberships and subscriptions. This was seconded by Don Gilson. Voted and Carried. (M.A.C. Dues)

3. A motion by Henning and seconded by Gilson to transfer from Contingency to line item #838, Maintenance of other county property, \$800.00. Voted and carried. (Rental of Social Services Building M.E.S.C.)

Shepard moved, supported by Reed, to approve item 1. Voted and carried. Shepard moved, supported by Overway, to approve item 2. Voted and carried. Shepard moved, supported by Henning, to approve item 3. Voted and carried.

Shepard moved, supported by Henning, to approve payment of County bills for the month of June in the amount of \$19,585.71 as approved by the Audit Committee. Voted and carried.

Shepard then reported on the joint M.A.C. and Manpower Conference which was held at Milwaukee, Wisc. on June 3rd thru 5th, 1973. It was an interesting and informative meeting. He and Commissioner Henning reported on the M.A.C. region IV meeting held at Ann Arbor, June 25, 1973. Some of the topics discussed were: Bonding and proposed operation of the Courts within the State.

Shepard reported on Tax Allocation Board matters, particularly fixed millage. A suggested division being as follows:

Schools	8.50
County	6.00
Township	1.10
Intermediate Schools	.25
Total	15.85

RE: Appointing a person to check on Federal Grants.

Chairman Shinabery appointed Commissioner Dyle Henning as the person to investigate and recommend ways to secure Federal Grants for the county.

The Property Management Committee reported on the attempt to locate office space for District Court Probation Department. The matter was discussed. Chairman referred the matter back to the Property Management Committee to make further investigation and recommendations.

Gove reported a request by Prosecuting Attorney Newman for permission for himself and Pat Joslyn to attend the Annual Prosecutors Conference to be held at Mackinaw Island July 25th thru 28th. Zeeb moved, supported by Henning, to approve the request. Voted and carried.

Gove moved, supported by Shepard, to adopt the following resolution. Voted and carried.

RESOLUTION

WHEREAS, Lora Ripple has served Clinton County for more than thirteen years as Deputy County Clerk in charge of Vital Records and Chief Clerk of Elections, and

WHEREAS, Lora Ripple has been both diligent and faithful in the efficient discharge of her duties and by so doing has rendered an invaluable service to the County Clerk's Office and to the citizens of Clinton County.

THEREFORE, We the Clinton County Board of Commissioners wish to commend and extend our sincere thanks to Lora Ripple for her faithful and devoted service and to wish her a long and happy retirement.

FURTHER, that this Resolution be made a part of the minutes of this meeting of the Clinton County Board of Commissioners this third day of July, 1973.

Zeeb moved, supported by Reed, that the Chairman and Clerk be authorized to draft a letter and send to our State Representatives regarding a proposed State Tax Tribunal to deal with tax appeal matters. Voted and carried.

Hufnagel moved, supported by Chamberlain, to re-appoint George Craig and Gordon Piggot to the Soldier and Sailor's Relief Committee for a three year term. Voted and carried.

Chairman Shinabery appointed Harold Martin and Roger Overway to the Member Selection Committee for the Mental Health Board. Shepard moved, supported by Chamberlain, to confirm the Chairmans appointments. Voted and carried.

Martin moved, supported by Zeeb, to adjourn at this time and to meet again July 17, 1973 at 9:00 A.M. Voted and carried.

Meeting adjourned.

Tuesday July 17, 1973

The Clinton County Board of Commissioners met

Tuesday July 17, 1973 at 9:00 A.M. Prayer was offered by Donald Gilson. A pledge of allegiance was given to the flag. Roll was called and a quorum reported. Present were Derrill Shinabery, Harold Martin, Maurice Gove, Donald Gilson, Duane Chamberlain, Roger Overway, Dyle Henning, Alta Reed, Virginia Zeeb and Gerald Shepard. Also present were Betty Minsky, State Journal, and Jim Edwards, County News. William Hufnagel has undergone surgery at Clinton Memorial Hospital. His condition is reported good at this time.

Minutes of the July 3, 1973 meeting were presented. Corrections were made. Henning moved, supported by Shepard, to approve the minutes as corrected. Voted and carried.

Communications:
1. A letter from the Clinton County Association of Assessing Officers stating they recommend to the Board of Commissioners that a re-appraisal be made of Clinton County was read. The matter was discussed. Leon Thelen, County Equalization Director, estimates that the cost will range from \$10.00 to \$13.00 per parcel. Data processing was also discussed. Shepard moved, supported by Gove, to instruct the Equalization Director to secure cost estimate figures on a county re-appraisal. Voted and carried.

2. A reminder from Robert Dittmer that the stand-by generator purchased for emergency use at WRBJ, in cooperation with the Civil Defense Program, has not been made ready for use. He urges the Boards early consideration of the same. Shepard moved, supported by Reed, to refer the matter to the Property Management Committee with power to act. Voted and carried.

3. A communication from The Commission on Aging by D.N. Devendorf, Field Representative, states they are on record in support of proposed legislation (H.B. 4827) sponsored by Rep. Charles H. Varnum which will require each county in the state of Michigan to establish a County Commission of aging. They seek support for the legislation. Henning moved, supported by Reed, to refer the matter to the Government and Personnel Committee. Voted and carried.

Gove presented a request from County Clerk, Ernest E. Carter, for permission to attend the Annual County Clerk Convention to be held at Marquette Michigan, August 20th to 24th. Reed moved, supported by Gilson, to approve the request. Voted and carried.

Register of Deeds, Willard Krehel also requests permission to attend his Annual Convention at Petosky, Michigan July 22nd to 25th. Gilson moved, supported by Zeeb, to approve the request. Voted and carried.

Chairman Shinabery instructed the Clerk to inform each

Department to submit their requests for permission to attend their Annual meetings to the Audit Committee for approval.

The Board recessed for Committee meeting at 10:00 A.M. Upon resuming session Sheriff Hufnagel appeared and with Chairman Shinabery presented award to Deputies Dennis Warren & Paul St. Johns, for meritorious service performed above and beyond their line of duty as Deputy Sheriffs for Clinton County.

Commissioner Gove presented Lora Ripple with a distinguished service award.

Chairman Shinabery referred the matter of establishing speed limits on Clinton County Secondary road to the Land Use Committee for study.

Paul McNamara, Clinton Memorial Hospital, and Paul Hubbard who represents the Tri-County Emergency Medical Services Council appeared. They are trying to enlist the cooperation of the Tri-County police, fire, civil defense, hospital and ambulance services in securing grant funds from the Robert Wood Johnson Foundation. These funds would be used to start-up and organize an improved emergency communication system including "911" emergency telephone communication system. Gilson moved, supported by Zeeb, to direct Chairman Shinabery to answer their letter of request in the affirmative. Mr. McNamara states that it is the position of the hospital that this type of service would exert a beneficial effect on the community. The motion was then voted and carried.

Gove reports that Judge Green is negotiating with a couple to replace Mr and Mrs Nobis at the childrens home who will retire soon. They are now employing one additional person for night time supervision. Gove moved, supported by Reed, to authorize Judge Green to engage the proper persons and to authorize a salary of up to \$20,000.00 for two (2) professional people. This action will include a counseling service at the home. Voted and carried.

Reed moved, supported by Shepard, to approve Commissioners expense accounts as presented. Voted and carried.

Chamberlain reports that the Parr Bldg, with approximately nine hundred (900) square feet is available for rent at a monthly rate of \$195.00 a month which includes heat and water. Zeeb moved, supported by Overway, to authorize the Property Management Committee to rent office space in the Parr Bldg, for the Zoning Department. Voted and carried.

Zeeb moved, supported by Shepard, to adjourn at this time and to meet again August 7, 1973 at 9:00 A.M. Voted and carried.

Meeting adjourned. Clerk Chairman

St Johns Little Leaguers take Jaycee All-star Tournament



These St Johns All-Stars defeated the Westphalia All-Stars Saturday 8-4 to take the District 18 Jaycee Little All-Star Tournament Championship. Members of the team are (front, from left) Brian Romig, Tom Thurston, Kevin Bloomfield, Rich Carter, David Seilke, Duane Rudy, Jim Dedyne, Jeff Rice, Steve Lenon, Mike Doerr (manager) Terry Churches, Ron Stollsteimer, Doug Kurlipla, John Shaver, Craig Goff, Jeff Morlarity, Todd Ballinger, Dean Cronkhite and Ed Lenon (coach). They will play the other St Johns All-Star team at the Little League Field behind Bee's Chevy Olds Thursday night at 7 pm.



ST JOHNS ALL-STAR SMACKS HARD LINER TO LEFT



WESTPHALIA RUNNER SLIDES TO BEAT THROW TO THIRD



These Westphalia players took runner-up honors in the Dist 18 Jaycee Little League All-Star Tournament. They are (front, from left) Tom Pohl, Dan Thelen, Brian Weber, Rick Droste, Dave Bengel, Mike Belen, Ralph Thelen, Neil Thelen, Tod Droste, Steve Rademacher, Warren Hengebach, Kirt Bengel, Perry Thelen and Joe Schmitt. Teams from St Johns, Ovid, Elsie, Westphalia, Fowler, Corunna and Owosso competed in the tournament.

County 4-H members earn 1973 Fair recognition



Among the Rosette winners at the Clinton County 4-H Fair are (front, from left) Terry Howard, Mark Helbeck, David Schrader, Barry Brown, Steve VanVleet, Paul Simon, Mike Wilson, Dan Washburn and Monica Heller.



Leslie Kuenzle and her reserve champion steer with buyer Art Romig, St Johns Co-op, \$1.05 per lb.



Barry Brown and his champion hog with buyers Jack Maier (left) and Martin Kreger, Red Fox Restaurant, \$1.30 per lb.



Barry Brown and his champion lamb with buyer Art Romig, St Johns Co-op, \$1.50 per lb.



Cindy Exelbi and her reserve champion lamb with buyer Paul Jones, Owosso Livestock, \$1.05 per lb.



Monica Heller's reserve champion hog with buyer Joe Zelinski, Maple Valley Realty, \$1 per lb.



Rosette winners in last week's County 4-H Fair include (from left) Leslie Kuenzle, Pam Smith, Bernice Sullivan, Cindy Ferrigan, Donna Davis, Karen Green and Sue Striz.



John Enderle and his grand champion steer with buyers Charles Bracey, Production Credit Association, and Bob Darling, Federal Land Bank, \$1.40 per lb.

COMPLETE BODY WORK
AND GLASS REPLACEMENT
BOB'S AUTO BODY
800 N. Lansing Phone 234-2921

City of St. Johns
Notice of Public Hearing
Board of Appeals
September 11, 1973

To be held in the Municipal Auditorium, 121 E. Walker Street at 12:30 P.M.

Purpose: Appeal on the Zoning Administrator's interpretation of the Zoning Ordinance 245 to deny Mr. Dennis Worrall a building permit to erect a fireplace adjacent to his existing home. The proposed fireplace would protrude two feet from the house creating an 8' side yard when 10' is the required minimum.

Property Description:
Address: 900 N. Clinton
Tax Roll No: 1059
Legal Description: Avenue Addition, Block 1, North 40 ft. and south 20 ft. of Lot 26.

Randy L. Humphrey
Zoning Administrator

Public Notice
St. Johns
Planning Commission

The regular monthly meeting of the St. Johns Planning Commission scheduled for September 6, 1973 at 7:30 p.m. has been rescheduled for September 13, 1973 at 7:30 p.m., to be held in Commission Chambers, 121 E. Walker Street, St. Johns, Michigan.

City of St. Johns
Randy L. Humphrey
Secretary to the Planning Commission

City of St. Johns
Notice of Public Hearing
Board of Appeals
September 11, 1973

To be held in the Municipal Auditorium, 121 E. Walker Street at 12:30 P.M.

Purpose: Appeal on the Zoning Administrator's interpretation of the Zoning Ordinance 245 to deny Mr. Ransom Briggs a building permit to construct a home. The home would be on a platted lot, however, Mr. Briggs proposed side yards of 10' and 6' when 10' side yards is the required minimum.

Property Description:
Address: 1008 E. Walker
Tax Roll No: A portion of 831
Legal Description: Block 2, of Outlot R, Lot 7

Randy L. Humphrey
Zoning Administrator

THE GOVERNMENT OF
BATH TOWNSHIP
PLANS TO EXPEND ITS REVENUE SHARING ALLOCATION FOR THE ENTITLEMENT PERIOD BEGINNING

JUL 1, 1973 AND ENDING JUN 30, 1974

IN THE FOLLOWING MANNER BASED UPON AN ESTIMATED TOTAL OF \$18,880

ACCOUNT NO. 22 019 001
BATH TOWNSHIP, TOWNSHIP SUPERVISOR CLINTON COUNTY BATH, MICHIGAN 48808

DEPARTMENT OF THE TREASURY
OFFICE OF REVENUE SHARING
1500 PENNSYLVANIA AVE N.W.
WASHINGTON, D.C. 20220

(X) EXECUTIVE PROPOSAL: Check this block if this plan is based on an executive proposal.

(L) DEBT: How will the availability of revenue sharing funds affect the financing requirements of your jurisdiction?
 AVOID DEBT INCREASE NO EFFECT
 LESSEN DEBT INCREASE TOO SOON TO PREDICT EFFECT

(M) TAXES: In which of the following manners is it expected that the availability of Revenue Sharing Funds will affect the tax levels of your jurisdiction? Check as many as apply.
 WILL ENABLE REDUCING RATE OF A MAJOR TAX WILL REDUCE AMOUNT OF RATE INCREASE OF A MAJOR TAX
 WILL PREVENT INCREASE RATE OF A MAJOR TAX NO EFFECT ON TAX LEVELS
 WILL PREVENT ENACTING A NEW MAJOR TAX TOO SOON TO PREDICT EFFECT

PRIORITY EXPENDITURE CATEGORIES (A)	PLANNED EXPENDITURES (B)	PERCENT PLANNED TO BE FUNDED BY REVENUE SHARING (C)	PURPOSE (E)	PERCENT PLANNED FOR:			
				EQUIPMENT (D)	CONSTRUCTION (D)	ACQUISITION (D)	RETIREMENT (D)
PUBLIC SAFETY	\$	%	10 MULTIPURPOSE AND GENERAL GOV.	%	%	%	%
ENVIRONMENTAL PROTECTION	\$	%	11 EDUCATION	%	%	%	%
PUBLIC TRANSPORTATION	\$18,880.00	100	12 HEALTH	%	%	%	%
HEALTH	\$	%	13 TRANSPORTATION	%	%	%	%
RECREATION	\$	%	14 SOCIAL DEVELOPMENT	%	%	%	%
LIBRARIES	\$	%	15 HOUSING & COMMUNITY DEVELOPMENT	%	%	%	%
SOCIAL SERVICES FOR AGED & POOR	\$	%	16 ECONOMIC DEVELOPMENT	%	%	%	%
FINANCIAL ADMINISTRATION	\$	%	17 ENVIRONMENTAL CONSERVATION	%	%	%	%
TOTAL PLANNED EXPENDITURES	\$18,880.00		18 PUBLIC SAFETY	%	%	%	%
(N) ASSURANCES (Refer to Instruction C)			19 RECREATION & CULTURE	%	%	%	%
			20 OTHER(S) Specify	%	%	%	%
			21 OTHER(S) Specify	%	%	%	%
			22 OTHER(S) Specify	%	%	%	%
			23 TOTAL PLANNED CAPITAL EXPENDITURES	%	%	%	%

The news media have been advised that a complete copy of this report has been published in a local newspaper of general circulation. I have records documenting the contents of this report and they are open for public and news media scrutiny.

I assure the Secretary of the Treasury that the statutory provisions listed in Part G of the Instructions accompanying this report will be complied with by the recipient government with respect to the entitlement funds reported hereon.

David L. VanBockle, Supervisor
DATE: August 15, 1973

Obituaries

Margaret Dunkel

CORTEZ, COLO. -- Margaret Mae Dunkel, 81, died June 21 here. She was a former resident of the Ovid vicinity for 60 years. Services will be held at Maple Grove Cemetery in Ovid on Saturday, Aug 25. The Rev. Claude B. Ridley will officiate.

She was born in Shiawassee Co., May 7, 1893, and attended Victor Twp schools. She and Harry Dunkel were married Aug 27, 1920. She was a member of the Methodist Church.

Surviving are 2 sons, John E. Castle of Lima, Ohio; and Vernon Castle of Las Vegas, Nev.; 3 daughters, Ariene Gee, Cortez, Colo.; Jane Robson of Las Vegas; and Bonnie Machen, also of Las Vegas; and 1 brother, Cecil Bennett, Lansing.

Emma Goosey

OVID -- Emma R. Goosey, 82, E M-21, died Aug 19 at Memorial Hospital, Owosso.

Funeral services will be held Aug 25 at the Cater Funeral Home, Moberly, Mo. Burial will be made at Oakland Cemetery, Moberly. Arrangements are being handled by the Houghton Chapel of Osgood Funeral Homes.

Pearl Rehm

Pearl Rehm, 84, 5587 Willow Hwy, Grand Ledge, former resident of Ovid, died Aug 14 at Clark Memorial Home in Grand Rapids.

Funeral services were held Aug 16 at Peters and Murray Funeral Home, Grand Ledge, with burial at Mt Rest Cemetery. The Rev. Charles Nordean of First United Methodist Church, Grand Ledge, officiated.

She was born in St. Johns, June 16, 1889 to Mr. and Mrs. David Stedman. She resided in Ovid most of her life, and was married to the late Edward Rehm.

Surviving are 1 daughter, Mrs. Walter Eschtruth, Grand Ledge; a step-daughter Mrs. Merrill Irwin of Perrinton; 1 brother, Carl Stedman, Birmingham; 3 grandchildren, 5 great-grandchildren, 6 step-grandchildren and 12 step-great-grandchildren.

Nancy Haynes

ST. JOHNS -- Nancy M. Haynes, 90, 206 Brush St., died Aug 16 at Clinton Memorial Hospital following a lengthy illness.

Funeral services were conducted Aug 20 at Osgood Funeral Home. The Rev. Francis Johannides officiated, with interment at Mt Rest Cemetery.

A homemaker all her life, she was born in Genesee Co. on Sept. 19, 1882 to Simon and Sophronia (Williams) Hewitt. She married Adelbert Haynes in Gratiot Co. in November of 1898. He died in 1943.

She resided in St. Johns most of her life where she was a member of First United Methodist Church.

Survivors include 4 daughters, Flossie Haynes, Donna Rae Haynes, and Frieda Haynes, all of St. Johns; and Evelyn Sheldon, Grand Rapids; 1 son, Lloyd of St. Johns; 15 grandchildren and 29 great-grandchildren.

Peter Grodiak

ST. JOHNS -- Funeral services were held Aug 21 at St. Joseph Catholic Church for Peter Grodiak, 37, 407 N. Morton St., who died Aug 18 in DeWitt Twp following a short illness. The Rev. Fr. William Hanker officiated, with burial at Mt Rest Cemetery. Scripture services were conducted at the Osgood Funeral Home Aug 20.

He was born in St. Johns, June 12, 1936 to William and Katherine (Hatta) Grodiak, Sr., and resided most of his life in St. Johns. He graduated from Rodney B. Wilson High School in 1954, and was employed as a machine operator at Oldsmobile in Lansing.

Mr. Grodiak and Patricia Ann Ohm were married in Lansing. She survives. He was a member of St. Joseph Catholic Church.

Surviving in addition to his widow are a daughter, Julie, and 1 son, Peter, both at home; 4 brothers, John, Chicago; Nick, William and Michael, all of Lansing; his mother, Katherine Grodiak, Lansing; and 2 sisters, Mary Atwell of Howell, and Anna Thelen, Fowler.

Lee Kiger

BATH (c) -- Funeral services were held for Lee C. Kiger, 89, of 14820 Webster Rd., at the Carter Funeral Home in Elsie Tuesday, Aug 14 with the Rev. Albert Dominic officiating. Burial was made in Pleasant Hill Cemetery in Bath.

Mr. Kiger passed away Saturday afternoon, Aug 13, at Provincial House North in East Lansing. He had been ill for several years.

Mr. Kiger, the son of Adam and Amanda Kiger, was born July 9, 1884 in Mt. Pleasant, Iowa. He resided in Michigan most of his life, primarily in the Lansing area and was married to the former Roseann Sawdy. He was a carpenter and a member of the Methodist Church.

Charles Cassel

LAINGSBURG -- Charles J. Cassel, 77, 539 E. Wieland Rd., died Aug 17 at Sparrow Hospital, Lansing.

Funeral services were held Aug 20 at the Lee R. Rummell Funeral Home in DeWitt. The Rev. Paul Drummond officiated with burial at Chapel Hill Memorial Gardens in Lansing.

He was born in Williams County, Ohio, Dec 1, 1895 to Samuel and Sarah Cassell. A mechanic with General Motors Corp., he and the former Ruth Davison were married in Lansing Oct 3, 1921, where he resided most of his life.

Surviving in addition to his wife Ruth are 1 daughter, Naomie Mayes, Lansing; 2 sons, Cleo of DeWitt and Gerald of Lansing; 2 sisters, Mary Corwin, Lansing and Bessie Jenks of Oregon; 18 grandchildren and 7 great-grandchildren.

Royal Ellinger

ELSIE (c) -- Funeral services for Royal Ellinger of 5388 Watson Rd. were held Saturday afternoon, Aug 18 at the Carter Funeral Home in Elsie. The Rev. David Litchfield officiated and burial was made in Duplain Cemetery.

Mr. Ellinger died Thursday morning, Aug 16, at St. Lawrence Hospital in Lansing of a heart ailment.

Mr. Ellinger was born June 9, 1911 in Duplain Township, the son of George and Millicent Ellinger. He resided all of his life in the Elsie area where he was a farmer and worked for the Soil Conservation Dept.

He was a member of the Duplain United Methodist Church and the Farm Bureau.

He is survived by a sister, Mrs. Alice Seger of Brighton; a niece and a nephew.

Hugh Hafelin

LAINGSBURG -- Hugh Ross Hafelin, 79, 8695 Chandler Rd., died Aug 16 at his home following a long illness.

Funeral services were conducted at the Lee R. Rummell Funeral Home, DeWitt, Aug 19. The Rev. Robert Prange and the Rev. Willard Farrier officiated, with burial at South Ovid Cemetery.

He was born in St. Johns, Oct. 30, 1893 to George and Linnie Hafelin. A former resident of Ovid, he moved to Laingsburg in 1942.

Mr. Hafelin and Nella E. Decker were married in Bannister, March 15, 1913. She survives. He was employed as a farmer all his life.

Other survivors include 4 daughters, Gladys Daugherty, Lansing; Ethel George, Lansing; Pauline Graham, St. Johns; and Dessie Curtis of Omeco, Fla.; 1 son, John of Owosso; 14 grandchildren; 38 great-grandchildren; 1 brother, Ivan of Sanford; 3 sisters, Ethel Baker, Ovid; Dessie Alzner; and Beula Rogers of Higgins Lake.

We Salute!
4-H LEADERS MEMBERS PARENTS

More fair award highlights



Mark Heibek - Vegetable gardening



Karen Munson - Western horsemanship



Patricia Tenlen - Sweepstakes trophy & western fitting

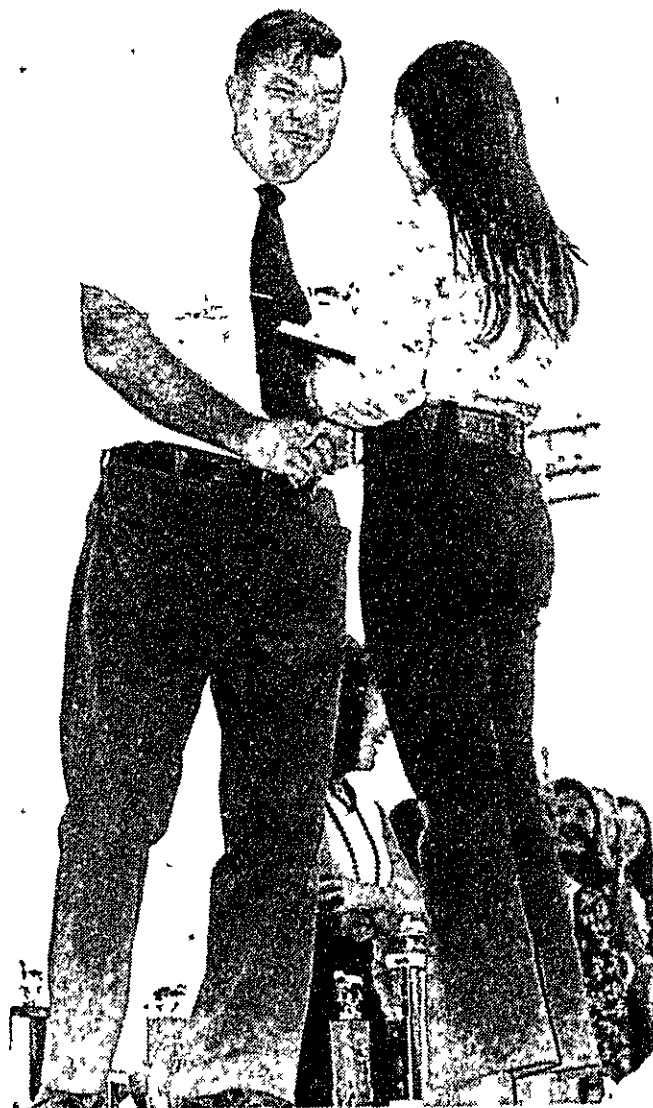

Leslie Kuenzi - Reserve champ steer & senior beef showmanship



Carl Tenlen - Pony horsemanship



Debbie Young - Champion English

+
Help it. Work.
The American Red Cross.



Open Letter
from VAN W. HOAG

Dear friends,

It deserves emphasis that the time, the place, the character of the funeral service, the merchandise used, the cemetery selected - these are decisions of the family of the deceased. The funeral director acts only as a representative of the family.

The clergyman should be consulted in matters that concern him before any decisions are made.

Respectfully,

Van W. Hoag
Hoag Funeral Home
ST. JOHNS, MICHIGAN

COMMON SENSE

It's what's needed at every difficult time in life, including the most difficult one. And it's what should guide you in deciding how much to spend for funeral service.

OSGOOD FUNERAL HOMES
OSGOOD Chapel COERGE Chapel
ST. JOHNS FOWLER
ABBOTT Chapel HOUGHTON Chapel
MAPLE RAPIDS OVID

WRBJ

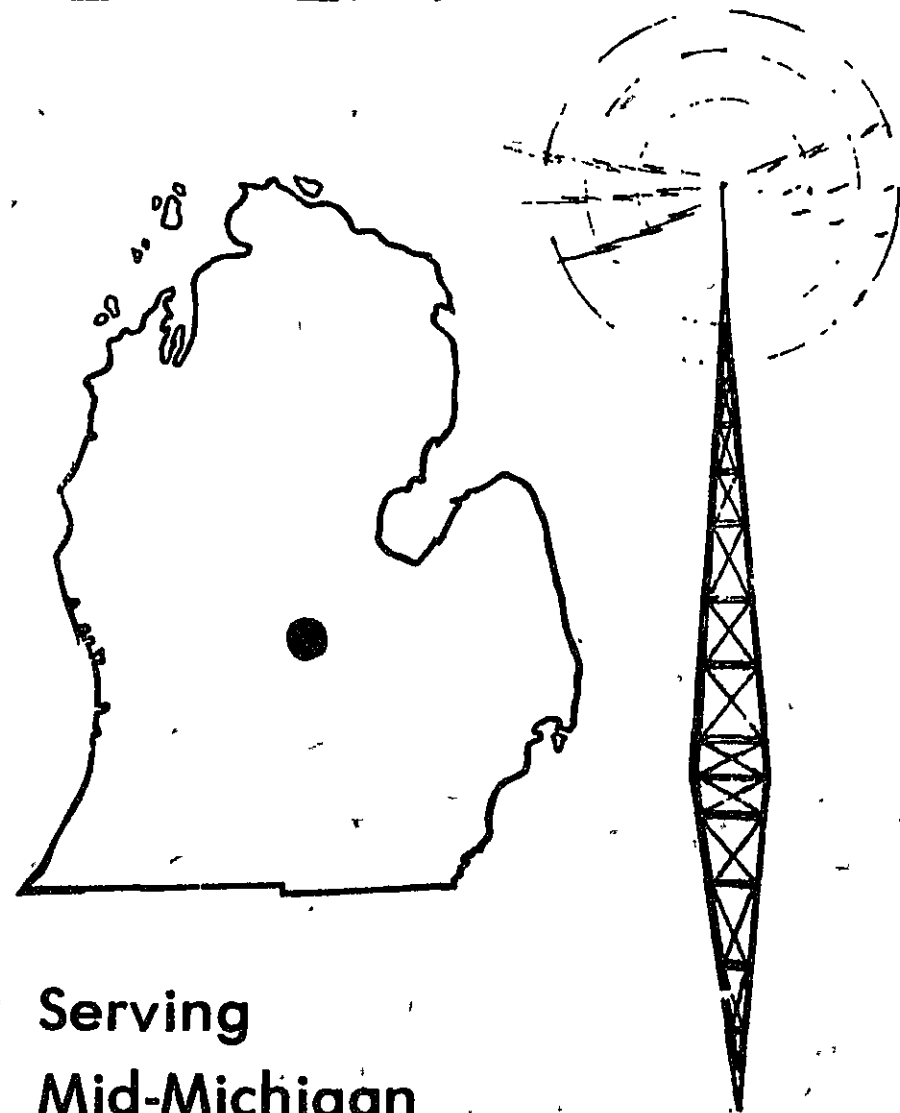

Serving
Mid-Michigan
with Beautiful Music
A-M 1580 F-M 92.1

Wickes

GRAND OPENING

Wickes
is the place for
values in...
PLUMBING



See
Wickes for the
Finest in
Bath Fashion

Tub and Shower Enclosure

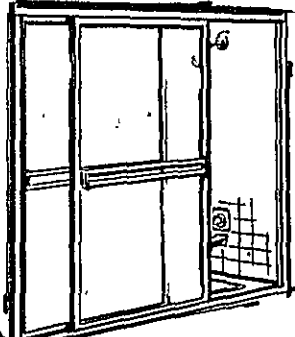

60" Tempered glass,
easy sliding doors.
Attractive pattern.
Anodized aluminum
framing. Our best model.

\$37.95
Reg. \$44.95

60" PLASTIC SHOWERFOLD
ENCLOSURE **\$37.95**

a Complete Plumbing Department

Visit Wickes complete plumbing department.
You'll find every item needed. Pipe, fittings,
fixtures—all of the essentials and lots of
helpful advice.



Time Payment Plan

Wickes has a time payment plan for all your
home building and remodeling needs. Stop by
our credit TP.



Installed Service

For the not-so-handy handyman.
Buy it installed. Put Wickes to
work for you.

Prices
Good Thru
SEPTEMBER 5

Reverse Trap TOILET

Beautiful white china.
Operates quietly and
efficiently. Modern
styling to enhance
your bath.

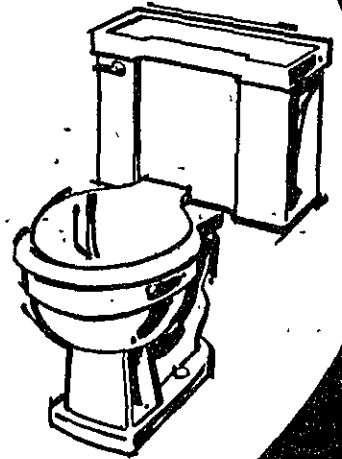

\$28.88
Reg. \$31.95

WOOD TOILET SEAT **\$2.79**
White enamel finish Reg. \$3.29

Recess Steel TUB

5 ft. one-piece durable construction. White
porcelain finish resists stains and scratch-
ing. Modern styling to compliment any
decor.

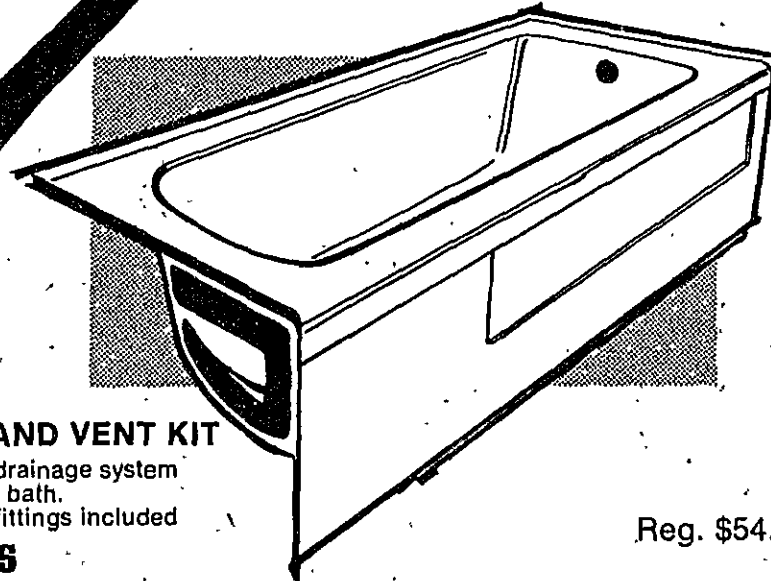

\$49.88
Reg. \$54.95

DRAIN AND VENT KIT

Complete drainage system
for 3-piece bath.
All pipe & fittings included

\$49.95

40 gallon gas Water Heater

Glass lined tank for long
life. Fiberglass insulation
keeps water hot...ends
those cold showers.

\$59.88
Reg. \$69.95

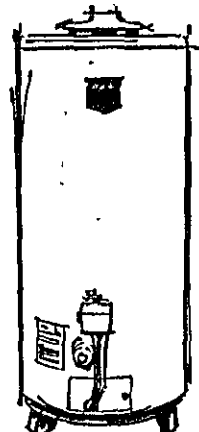

40 GALLON ELECTRIC
WATER HEATER **\$59.88**
Reg. \$69.95

24 inch Starline Vanity

White vinyl laminated base,
white formica spindrift top.
Lavatory included.
Modern styling.

47.68
Reg. \$53.95

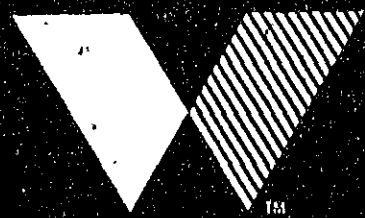
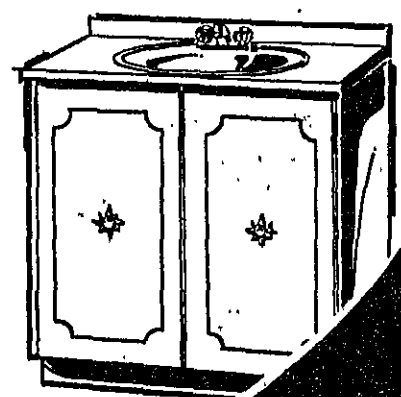

Wickes Lumber



3680 West Monroe Road
ALMA, MICHIGAN
Telephone: 463-4936

Store Hours: Mon. - Thurs. - 8 a.m. - 5:30 p.m.
Fri. - 8 a.m. - 9 p.m.
Sat. - 8 a.m. - 4 p.m.

THESE GRAND OPENING VALUES ALSO AVAILABLE
AT THE WICKES CENTER IN CLARE

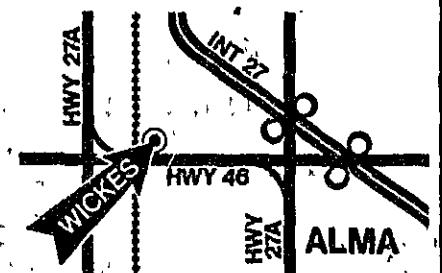

Results of Clinton County 4-H fair

KNITTING Young Miss

Group A
Debra Armbrustmaier, Kris Aylsworth, Debra Beck, Janine Bower, Lisa Brook, Robin Brown, Jeff Conklin, Mary Ellen Dvereaux, Bonnie Elster, Peggy Falvor, Mae Farley, Paul Fedewa, Ruth Ann Fedewa, Juli Feldpausch, Mary T. Feldpausch, Miry Feldpausch, Susan Feldpausch, Leslie Fongers, Leslie Foy, Diane George, Shirley George, Shari Hubeler, Carol Huguelot, Theresa Hurst, Thresa Klein, Lois Koenigsnecht, Janice Martin, Pam Mathias, Melinda Minarik, Beth Myers.

Betty Myers, Laura Myers, Melissa Noffs, Kathy Platte, Laurie Platte, Cynthia Pung, Michelle Ritz, Susan Schaefer, Lori Schaefer, Sandy Schmitt, Amy Schmitz, Julie Schmitt, Stephanie Smith, Mary Ellen Spitzley, Kathy A. Thelen, Piggis M. Thelen, Sandra C. Thelen, Katy Volsinet, Andrea Walsh, Rosemary Wieber.

Group B

Teresa Barker, Carolyn Buggs, Sally Buggs, Connie Cooper, Janet Farley, Doreen Fedewa, Janet Fedewa, Lisa Foy, Debbie Geller, Mary Gene Harmon, Lori Huguelot, Christina Hunt, Beth Jakus, Marbeth King, Sue Klein, Angela Lipski, Jane Miller, Kimberly Paks, Cindy Platte, Laurie Reid, Kristine Schaefer, Beth Ann Schaefer, Ann Marie Schmitt, Beverly Schmitt, Carol Simmon, Brenda Thelen, Ami Wohlfert.

Junior Miss

Group A
Susan Aylsworth, Debra Burnham, Gerilyn Falvor, Sandra Fedewa, Karen Green, Sheri Harte, Linda Kramer, Kim Lonsberry, Lauri Love, Pamela Schaefer, Catherine Schlarf, Barbara Schmitt, Linda Schomisch, Charlene Shen, Anne Sliote, Julie Tall, Lois A. Thelen, Lynn M. Thelen, Linda Thornton, Debbie White.

Group B

Gerl Fedewa, Susan Malkin.

Group C

Jill Cook, Michelle Cornell.

Senior Miss

Group A
Cathy Anders, Deb Ballantine, Linda Bappert, Helen Blakely, Ruth Brya, Connie Cordes, Virginia Cordes, Carol Falor, Cathy Fandel, Sue Fox, Clarice Krebichl, Marian Kurnez, Darcella Krebichl, Sue Miller, Miriam Nechazel, Vicki Schesch, Diane Schmitz, Susan Schmitt, Diane Schomisch, Sarah Seeger, Kathleen Spitzley, Debbie Stanley, Bernice Sullivan, Charles Tall, Lorene Tall, Debbie Thelen, Mary Lee Thelen, Diane Waters, Carolyn Bennett.

Group B

Nancy Anders, Kathy Harmon, Cathy Howell, Rhonda Schaar, Ruth Smith.

LEATHERCRAFT

Group A
Eugene Bellinger, Tim Bellinger, David Dubay, Richard Ferrall, Leslie Hazle, Lisa Hicks, Daniel Rademacher, Gerald Rademacher, Kenneth Schaefer, Alan Simmon, William Thies, Michael Tiedt, Chris Weber, Rex Ballantine, Kris Faughl, Teresa Fedewa, Diane Vitek.

Group B

Curt Becker, Richard Cortright, Clifford Hengesbach, Richard Plino, Bruce Schaefer, Jim Staffey, Dale Young, Brina Davis, James Thies.

LEISURE EDUCATION Ceramics

Group A
Sharon Bappert, Philip Brasington, Jim Brasington, Linda Schomisch, Mark Slowinski, Chris Fairchild, Victor Hengesbach, Sheryl Smith, Dawn Vining, Jeff Brasington, Eric Brockmyre, Diane Mapes, Leola McKeachie, Lois Purclase, Robbin Purfill, Morrie Roberts, Donna Stevens, Helene Stratton, Susan Stratton, Todd Walker, Susan Woodhams, Teresa Morters, Rhonda Lee.

Group B

Paul Pung, Ronald Schaefer, Michael VanRooyen, Tammy Woodbury, Daniel Fedewa, Kathleen Baese, Cheryl Conklin, Loren Conklin, Penny Dunigan, Donna Feldpausch, Sarah Haviland, Rita Horman, Hedmann Hunt, Tammy Hunt, Kim Ingalls, Debbie Jegla, Kim McElroy, Delores Plaza, Gloria Pica, Anne Pung, Pamela Roberts, Diane Schomisch, Beth Schumaker, Suzy Schumaker, Mary Selike, Laurie Sillman, Theresa Slowinski, Debbie Telling, Lori Vining, Todd Walker, Cindy Ward, Randy Ward, Debbie White, Shelly Wilkes, Lynne Wilkie, Paul Wilkie, Scott Wilkie, Bonnie Elster, Lori Feldpausch, Rhonda Kanaski, Lori Laskaway.

Group C

Barry Bernath, Suzanne Bond, Michelle Cornell, Kathy Eaton, Mary Fedewa, Lisa Foy, Don Gladstone, Debbie Grennell, Starr Louth, Roseanne Rossow, Ronald Schaefer.

Cake Decorating

Group A
Doris Barnhart, Jamie Barnhart,

Jeanine Barnhart, Helen Blakely, Sandra Bodell, Barbara Dilla, Carol Falor, Jane Fedewa, Ruth Fedewa, Sandra Fedewa, Lisa Hicks, Shawn Holcomb, Roxanne Husted, Barbara Lehman, Leola McKeachie, Sandra Messer, Janet Miller, Dalicia Mitchell, Susan Mitchell, Cathy Schlarf, Beth Schumaker, Laurie Sillman, Kathleen Simon, Esther Smith, LuAnn Smith, Donna Slover, Helene Stratton, Debra Thelen, Therese G. Thelen, Lisa Wing, Maria Schaefer.

Group B

Janice Ballinger, Jayne Devereaux, Karen Fedewa, Donna Feldpausch, Larie Feldpausch, Sharon George, Debbie Grennell, Judy Hafner, Shawn Holcomb, Roxanne Husted, Annette Irish, Linda Jandernoa, Cathy Matice, Marilyn Pung, Diane Rensberry, Kathleen Spitzley, Susan Stratton, Judy A. Thelen, Kay Thomas, Gretchen Vanderstow, Lynne Wilkie, Linda Wirsan.

Painting & Drawing

Group A
Shawn Bergan, Kim Clark, John McNeilly, Rose Oberlin, Laure Palmer, Therese Palminter, Kris Rees, Brenda Berythill, Kim Clark, Rick Dunigan, Michele Bases, Kim Clark, Brett French, Sondra Hoffebower, Kris Rees, Amy Zhulkie, Sawn Bergan, Brenda Berythill, Kim Clark, Darcy French.

Group B

Rick Shieren, Diana Hoffebower, Kim Lonsberry, Cindy Gladstone, Rose Oberlin, Terry Will, Kim Clark, Belinda Morris, Brett French, Kim Lonsberry.

Group C

Cindy Nicholas, Karen Wheeler, Patricia Wheeler.

Creative Writing

Group A
Shirley Hengesbach, Rose Oberlin, Susan Striz, Chris G. Thelen, Therese G. Thelen.

Other Crafts

Group A
Linda Andrews, Lora Austin, Michelle Austin, Brenda Bancroft, Cheryl Bancroft, Lisa Brook, Carrie Curtis, Karen Curtis, Shawn Curtis, Todd Curtis, Sherri Desprez, Leslie Foy, Darcy French, Arlene Galbavi, Diana Hoffebower, Kevin McDougall, Rose Miller, Terri Patterson, Jackie Peters, Kris Rees, Karen Reeves, Cindy Reynolds, Linda Schomisch, Darlene Skym, Mary Ann Smith, Patty Sella, Lynda Vermeersch, Susan Woodhams, Bruce Woodward.

Group B

April Zhulkie, Amy Wohlfert, Kris Aylsworth, Susan Aylsworth, Sally Buzung, Virginia Bozung, Sandra Fedewa, Martin Feldpausch, Beckie Gibson, Harry Moldenhauer, Beth Myers, Betty Myers, Kelly Paks, Kim Smith, Randy Ward, Stacie Hufnagel, Teresa Marten, Roseanne Rossow, Lisa Day, Julie Huntton, Lorie Huntton, Barbara Lehman, Cindy Lehman, Sue Lehman, Sandra Lock, Teresa Smoyer, Andrea Walsh.

Group C

Natalie Brook, Debra Burnham, Kathy Goff, Beth Jakus, Leah Jakus, Colleen Nitschke, Rose Oberlin, Joyce Riley, Sharon Schomisch, Joann Seeger, Rick Sheren, Kelly Spooner, Sue Ann Suehek, Diane Vitek, Tammy Young, Teresa Barker, Mary T. Feldpausch, Minday Feldpausch, Lori Hufnagel, Kelly McElroy, Laura Myers, Tonnie Schaefer, Daniel Schaefer, Lisa Schaefer, Rhonda Kanaski, Pamela Hufnagel, Paul Pung, Linda Schomisch, Sandy Sausley, Chris Chamberlin, Pam Chamberlin, Julie Day, Linda Wesseler.

Group D

Kevin Young, Stephanie Smith, Carol Falor.

PERSONAL IMPROVEMENT Home Design

Group A
Susan Aylsworth, Kim Clark, Teresa Clark, Beckie Gibson, Kathi Haviland, April Hugelson, Robbin Purfill, Diane Vitek, Patty Walling, Darlene Wilson.

Group B

Becky Kaufman, Therese G. Thelen.

Group C

Barb Ramsey, Amy Wohlfert.

The Family

Group A
Lois Ashley, Kris Aylsworth, Judith Brown, Renee Fouche, Dawn Gelsenhaver, Debbie Gibbs, Luann Hopp, Delores Plaza, Anne Pung, Pamela Roberts, Diane Schomisch, Beth Schumaker, Suzy Schumaker, Mary Selike, Laurie Sillman, Theresa Slowinski, Debbie Telling, Lori Vining, Todd Walker, Cindy Ward, Randy Ward, Debbie White, Shelly Wilkes, Lynne Wilkie, Paul Wilkie, Scott Wilkie, Bonnie Elster, Lori Feldpausch, Rhonda Kanaski, Lori Laskaway.

Group B

Debra Burnham.

Group C

Kathi Haviland, Becky Kaufman, Chris Thelen, Therese G. Thelen, Jeannine Wood.

Group D

Kurt Parker, Lorraine Phillips, Diane Vitek.

PHOTOGRAPHY

Group A
Erion Barks, Leslie Foy, Sue Payne.

Lisa Foy, Bev Howe, Pat Zeeb, Dan Washburn, Brian Brook, Romona Hubbard, Annette Todoseck, Steve VanVleet.

Group B

Laura Bauerle, Everett Thornton, Debbie Grennell, Maurice Harvey, Marie Miller, Jeff Pearson, Jim Thelen, Robert Mee, Mark Grennell, Pat Eastment, Mary Bergdoll, Wendy Brockmyre, Todd Curtis, Dennis DeMarest, Patty Eastment, Kathleen Fedewa, Bill Huguelot, Mitch Jone, Jay Miller, Bonnie Rossow, Suzy Schumaker, Doug Thelen, Brad VanVleet, Jeff VanVleet, Jeannine Seeger, Sarah Seeger, Jean Divine, Beckie Gibson, Clarice Krebichl, John McDougall, Jeff Thornton, Kathy Valentine, Cindy Ward, Pat Zeeb, Mark Barz, Kathy Valentine, Steve VanVleet, Timothy Barz, Earl Flegler, Amy Todoseck, Cheryl Bancroft, Jeff VanVleet.

Group C

Susie Phillips, Gary Reeves, Debra Burnham, Lorraine Phillips, Greg Tarrant, Brad VanVleet, Eric Brockmyre, John Harvey, Dennis DeMarest, Dwayne Dush, Harry Todoseck, Scott Wilkie, Victor Hensberry.

POULTRY

Group A
Terrie Speer, Tim Weaver, John Harvey, Cindy Risley, Gayla Risley, Sandy Williams, Ann Weaver, Jeff Haze.

Group B

Bruce Rossow.

RABBITS

Group A
Jerry Price, Clair Rowland, Bobby Burgdorf, Ruth Fedewa, Sandra Fedewa, Randy Frenchen, Shawn Holcomb, Starr Louth, Bruce Pohl, Calvin Rice, Linda Thelen, Barrett Hlaylock, Sandra Fedewa, Debbie Gibbs, Mark Hebeck, Monica Heller, Charles Krebichl, Lori Krebichl, Kevin McDougall, James Pohl, Debra Price, Jerry Price, Cheryl Rademacher, Gary Rademacher, Mark Rademacher, Colleen Rowland, Judy Thelen, Brenda Vance, Barbara Yanz, Steve Schneeburger, Leo Heller.

Group B

Debra Price, Patrick Arens, Clifford Hengesbach, James Williams, Patty Williams, Sandy Williams, Ruth Fedewa, Sharon Malkin, Gerald Rademacher, Clair Rowland, Kevin Thelen, Leslie Vermeersch, Bruce Schaefer.

Group C

Steve Eaton, Jane Miller, Allsha Yanz.

SAFETY First Aid

Group A
Jeff Crandall, Robbin Lawson, Bruce Orweller, John Watkins.

Group B

Lucy Evans, Stephanie Lawson, Brian Orweller, Irvin Pettit, Jeff Wagner.

Group C

Chris Pung, Esther Smith, Debbie Thelen, Randy Wing.

Group D

Carolyn Barrett, George Davis, David Pung, Armond Smith.

Group E

Allen Plowman.

Group F

Landscaping
Rod Thornton.

Group G

Special Exhibits
James Pohl.

Group H

Jeffrey Wohlfert.

SHEEP

Group A
Cindy Exelby, Bev. Howe, Cindy Exelby, Bev. Howe, Barry Brown, Cindy Exelby, Bev. Howe, Chris Risk, Beth Schumaker, Ted Ashley, Suzy Schumaker.

Group B

Deveraux, Robert Davis, Dale Devereaux, Darlene Devereaux, Leo Heller, Monica Heller, Judy Marten.

Group C

Paul Adams, Ted Ashley, Barry Brown, Judy Brown, Dale Devereaux, Ed Falvor, Jerome Kuenzli, Lisa Kuenzli, Barry Brown, Judy Brown, Leo Heller, Monica Heller, Jolene Kuenzli, Lisa Kuenzli, Ted Ashley, Ed Falvor, Brad VanVleet, Bob Davis.

Group D

Steve Malkin, Bob Volsinet, Bob Davis, Steve Malkin, Bob Volsinet, Brian VanVleet.

Group E

Conservation
Wildlife
Barry Brown, Brenda Gelsenhaver, Colleen Nitschke, Lorraine Phillips, Gary Reeves, Brad Risk, Greg Tarrant.

Group F

Dale Burnham.

Group G

Gun Safety
Ronald Andrews, Terry Churches, Mark Grennell, Mark Hebeck, Greg Hunt, William McElroy, Steven Schneeburger, Sue Schneeburger, Mike Stevens, Terry Will, Daniel Will, Jeannine Wood.

Group H

Donald Andrews, Gary Andrews, Keith Bradley, Luntford Bradley, Duane Haviland, Jeff Hunt, Tammy Hunt, Nancy Johnson, Starr Louth, Debra Price, Jerry Price, Charles Valentine, Michael Wilson, Cindy Wohlfert.

Group I

Larry Johnson, Scott Wohlfert.

Group J

Angela Elder, Vincent Elder, Jeannette Smith.

Group K

Todd Goodrich, Paul Nichols, Carl Salander, William Salander, Gerald Salander.

Wildflowers

Group A
Cheryl Conklin, Loren Conklin, Mary Fedewa, Leslie Foy, Lisa Foy, Kathi Haviland, Sarah Haviland, Dorella Martin, Evelyn McComb, Lorraine Phillips, Susan Cornell.

Group B

Bruce Davis, Donna Davis, Douglas Davis.

Group C

Rocks and Minerals
Beth Myers, Charles Scripter, Steve VanVleet.

Group D

Starr Louth.

Group E

Group Exhibit
Bengal Community 4-H Club.

CROCIET

Group A
Elaine Miller, Theresa Bappert, Debbie Berythill, Karen Fedewa, Julie Platte, Roseanne Rossow, Jeanne Striz, Cheryl Bancroft, Kathy Bappert, Linda Dupert, Connie Cordes, Cindy Eavey, Susan Mitchell, Sue Schneeburger, Daine Schomisch, Esther Smith, Pam Smith, Jeannine Wood.

Group B

Brenda Bancroft, Laura Bauerle, Tyann Cobb, Mary Cordes, Christopher Palminter, Kevin Palminter, Matthew Palminter, Melissa Rock, Kristine Schaefer, Jeanne Fedewa, Lori Fox, Beverly Howe, Michael Palminter, Susan Tucker, Therese Thelen, Susan Woodhams, Julie Waller, Judy Hafner, Kim Howe, Rose Oberlin, Leanne Thelen.

Group C

Denise Fedewa.

CROPS

Group A
Tim Falor, Bruce Seyfried, Laura Bauerle, Ronald Bauerle, Steven Conklin, Bruce Seyfried, Charles Thelen, Chris Zeeb, Mike Zeeb, Pat Zeeb, Rita Kissane, Bruce Levey, Jim Hebel, William Horman, Bruce Seyfried, Paul Simon, Steven Conklin, Ed Falvor, Jim Hebel, Mike Simon, Charles Thelen, Dan Washburn, Check Falvor, Frank Falvor, Jim Hebel.

Group B

Pauline Kissane, Charles Sillman, Jim Falor, Bruce Seyfried, Cindy Thornton, Ed Falvor.

Group C

Chuck Falvor, Frank Falvor.

DAIRY

Group A
Loren Conklin, Daniel Fedewa, Sheri Harte, Tonnie Schraeder, Amy Striz, Jeanne Striz, Susan Striz, Kirk Baird, David Schraeder, Mark Baird, Charles Green, Amy Striz, Barbara Striz, Susan Striz, John Swagart, Lisa Wing, Karen Green, Jeanne Striz, Randy Wing, Steven Conklin, Karen Green, Dave Miller, Rodney Wing, Mike Zeeb, Karen Green, Jeanne Striz, Susan Striz, Charles Green, Dan Cable, Sarah Haviland, Christian Haviland, Kathi Haviland, Duane Hugelson, April Hugelson, Dexter Hugelson.

Group B

Cheryl Conklin, Karen Green, Sarah Haviland.

Group C

Doigs
Cathy Feeman, Joe Chesney, Paul Thelen, Julie Feeman, Lori Webster, Ann Graham, Jeannine Seeger, Sandy Webster, Dawn Archer, Mark Bruin, Mary Bruin, Dan Cable, Chris Cole, Cathy Feeman, Julie Feeman, Ann Graham, Kay Hivest, Kathy Root, Jeannine Seeger, Babette Sosebee, Roger Sosebee, Mike Thelen, Patty Thelen, Therese Thelen, Deb Webster, Sandy Webster.

Group D

Mary Bruin, Mark Gindher, Mike Thelen, Dan Cable, Kay Hivest, Deb Webster, Mark Gindher, Karen Weatherwax.

Group E

Chris Cole, Kevin Glanz, Kathy Root, Roger Sosebee, Gary Highbec, Babette Sosebee, Karen Weatherwax, Dawn Archer, Lori Webster, Mark Bruin, Therese Thelen.

Group F

Harvin Argersinger, Dorella Martin.

Group G

Mark Roxin.

WEATHER

Group A
Martin Musolf, Sharon Wood.

RECREATION

Group A
Mark Barz, Timothy Barz, Ricky Dunigan, Earl Flegler, Kim Howe, Jeannine Wood.

Group B

Group Exhibit - Fowler Busy Bees

FLOWER GARDEN

Group A
Theresa Batora, Debra Beck, Natalie Brook, Judi Brown, Debra Brunham, Kelly Eaton, Frank Falvor, Karen Fedewa, Cindy Ferrigan, Carrie Haynes, Michelle Haynes, Rita Horman, Allan Howard, Terry Howard, Lori Howell, Steele Hufnagel, Bill Huguelot, Kim Ingalls, Randy Ingalls, Pauline Kissane, Pam Kosloski, Darcella McMichael, Laurie McNamara, Marlen Musolf, Paul Nichols, Rose Oberlin, Cindy Ortiz, Joan Pawloski, Pam Race, John Richmond, Morrie Roberts, Pamela Roberts, Bonnie Rossow, David Schike, Sherrie Schike, Terry Selike, Tracy Selike, Theresa Slowinski, Archand Smith, Jeannette Smith, Bernice Sullivan, Marsha Swanson, Daniel Thelen, Debra Thelen, Doug Thelen, Betsy VanVleet, Brenda VanVleet, Jeff VanVleet, Cindy Ward, Darlene Wilson, Jane Witt, Susan Yallop.

Group B

Dawn Archer, Deb Ballantine, Carolyn Barrett, Jonathan Barz, Helen Blakely, Pam Chamberlain, Tyann Cobb, Donna Davis, Margaret DeVault, Randy Dilday, Penny Dunigan, Steve Dunigan, Bobby

Clinton County News
SECTION B August 23, 1973



John Enderle - Jr. Beef Showmanship

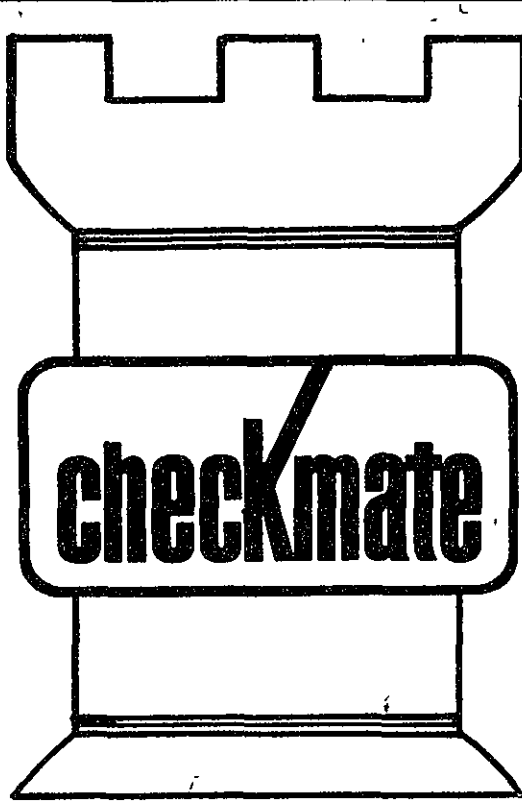

YOUR MOVE - FOR AN INSTANT LOAN JUST BY WRITING A CHECK

checkmate works . . . just like a do-it-yourself loan. When you open a Checkmate account, you receive a line of credit and if your checking account funds run short you simply write yourself a loan by writing a check.

checkmate saves . . . you steps by eliminating a run to the bank when your cash is low. You have the money you need for daily expenses, sales or emergencies right at the tip of your pen. Just by writing a check, you have all the cash you need up to the limits of your approved line of credit.

checkmate gives . . . you the privacy we all like when it comes to money affairs. And along with the privacy comes a convenience that only a plan like Checkmate can provide. . . instant cash. It's a checking account loan system that can't be beat.

MAKE YOUR MOVE TO **checkmate**

The wide-awake bank makes it all so easy.

CLINTON NATIONAL BANK and TRUST CO.
Serving The Clinton Area From 11 Locations

This Is Earl Haas Week

Next Sunday, August 26th, from 2 to 5 p.m. an open house at Smith Hall will publicly recognize Earl's retirement from the MSU Cooperative Extension Service, a field he has worked in since 1935. Earl came to Clinton County as Agriculture Agent in 1955 and since that time has distinguished himself both in his profession and as a member of the community. Professionally he was honored in 1960 by the National Assn. of County Agricultural Agents and presented the Distinguished Service Award. Outside his work he has long been active in civic projects and his past presidency of Rotary Club and past membership in the vestry of St. Johns Episcopal Church attest to his willingness to participate. We wish Earl happy years in his retirement and hope to add to the honor of his open house by selecting him as our citizen of the week.

CLINTON NATIONAL BANK & TRUST CO.

Clinton County News



HAROLD SCHWALTZ
Advertising Director
JIM EDWARDS
Editor

MEMBER
MICHIGAN
NEWSPAPER
ASSOCIATION - FOUNDED 1908

Back Through the Years



From the Clinton
County News files
of 1971, 1962, 1947

Railroading -- state style

Once again the St Johns City Commission is about to tangle with the Public Service Commission about railroad crossings.

Following an investigation prompted by a fatal accident, the Public Service Commission decided the city and the railroad should spend thousands of dollars to insure the prevention of accidents.

The city, while expressing their feelings of not wanting to be the cause of the vehicle-train accidents in the city, have opposed the expenditures called for by the Public Service Commission.

Earlier confrontations, with the Public Service Commission resulted in bruised relations and downright lost tempers.

We can't say we blame the City Commission for not bending over backwards to go along with the state agency.

In the first place, if we understand the reports correctly, the Public Service Commission acted in a way other state agencies have been known to do in the past.

That is to say, "this is the way we say it has to be done and that's the way you're going to do it."

That used to work in the Army and sometimes with small children, but don't hold your breath waiting for 1 government body to yield to another in such a fashion.

Among the recommendations of the Public Service Commission was one to shut off vehicle traffic across tracks in a few locations in town.

The City Commission feels St Johns needs the use of all the streets in town and we agree.

Another recommendation is for extensive revamping of the Clinton Ave railroad intersection to include crossing barriers.

Although there may be a margin of safety in such barriers, it is questionable if they would have prevented the accident initiating this whole matter.

Furthermore, why does the Public Service Commission feel St Johns needs such a device when hundreds of other towns the same size seem to do all right without them?

Also, we seriously question the necessity of the crossing barriers for 25 mph traffic in St Johns when a crossing on US-27 a few miles north of the Clinton County line is travelled over at speeds in excess of 65-70 mph.

In the days of declining rail service all over the country, it somehow seems ironic that St Johns is picked to spend thousands of dollars to install equipment that was never deemed necessary during the peak years of the railroad.

We concur with the statement made about the city attorney representing St Johns in the matter--"he resisted their (Public Service Commission) efforts with all of his efforts."

—JE



REP DOUGLAS TREZISE
87th District

During the period early in the year when we were discussing the tax reduction program, a lot was said and written about a new approach to senior citizen tax credits. Now that the program has been signed into law and the state treasurer is getting geared up to administer the plan, a closer look at it is in order.

It should be said at the outset that this new plan will bring increased benefits to practically all people in the over-65 age bracket. It is not limited to home owners but gives a break to those who rent as well.

The new program involves a complete change of philosophy from the present "homestead tax exemption" law. At the present time, a person who is over 65 years old and has less than \$6,000 of income is eligible to receive a reduction in the valuation of his homestead on the tax roll. Thus, if he owns a \$12,000 home which would have an equalized value of \$6,000, he would pay his taxes based on a value of \$2,500 after receiving his \$2,500 senior citizen exemption.

percentage of their income in property taxes. The schedule provides that, if income is \$3,000 or less the state will reimburse all the property taxes paid on a senior citizen's home, up to a maximum refund of \$500. If income is between \$3,000 and \$4,000, the reimbursement will be for all property tax which exceeds 1 percent of his income. For instance, if your income is \$3,500, your part of your taxes will be \$35 and the rest, again to a maximum of \$500, will be reimbursed by the state.

If income falls between \$4,000 and \$5,000, the percentage is 2 percent; between \$5,000 and \$6,000, the figure is 3 percent and, if income is over \$6,000, the reimbursement starts at 3-1/2 percent of income. In all cases the \$500 ceiling applies.

Senior citizens who rent rather than own their homes can consider 17 percent of the amount of the rent paid the same as property tax and file a claim for a refund according to the above schedule. For example, a person who pays \$1,000 in rent during a year can claim up to \$170 in tax refund—depending on his income—from the state of Michigan.

One of the most frequently asked questions about this plan is, "What is income?" People want to know if social security payments, pension income and other retirement funds are part of that base on which refunds should be computed. The answer is "yes". Since the plan is designed to give help in proportion to need, all income, regardless of source, is considered. There are a few exceptions (for instance, money from sale of property in which case only the capital gains portion would be considered) and these will be spelled out in the instructions.

Remember, the refund is applicable only to a person's home and property on which it is located. In the case of a farm, it includes all land and buildings contiguous to the home. If a person resides in a mobile home, he can claim his \$3 per month tax as property tax and also 17 percent of the rental for space can be claimed under the rental provisions of the law.

The most important thing to remember is that each person will have to apply for his refund even if he does not have income enough to pay a state income tax. Forms and instructions will be available in the fall and I will be glad to see that copies are sent out to you. Just drop me a card or call and leave your name and address and I'll put your name on the list.

Rep Stanley Powell missed no roll calls

on each of them. Two other state representatives share this perfect score. Other representatives missed varying numbers of roll call votes.

Citizens in the 88th State Representative District served by Stanley M. Powell of Ionia, are informed that a tabulation of official records, shows that there were 663 record roll calls in the Michigan House of Representatives during the first seven months of 1973 and Representative Powell is recorded as having voted

TODAY'S Real Estate
by HANK FURMAN

Which bank do you choose when you are ready to finance a large purchase, a house for example, or a piece of land? Your real estate man should be able to help you choose, as well as to give you information, on the best financing plans. Then it is up to you to do some shopping around. Take along a pencil and paper. Ask questions comparatively. Then you will be able to make an intelligent decision.

The mortgage dept at FURMAN REALTY CO, 1515 North U.S. 27, 224-3236 is available to assist you with all the details and will do all the processing for your mortgage. Members of the Lansing Board of Realtors, we invite you to call us with your listing for professional real estate service by real estate professionals. Hours: 8:30-5 Mon-Fri; 8:30-3 Sat; & by app't.

HELPFUL HINT:
Shutters give the outside of your house a homey look and add to their decoration. Why not see for yourself?



A PERSONAL LOOK AT THE NEWS

Between the lines

with Jim Edwards

One of my favorite words is "exasperation." Just the sound of the word seems to fit the situations in which it is used.

Here are a few of my exasperations:

...Busily swallowing the last bit of coffee in a cup—only to sickily discover it's stone cold.

...Eating in a restaurant while a party of several people engage in unending conversation while hovering over you.

...Finding out there's no coffee in the house on a Sunday morning.

...Getting ready in plenty of time for an appointment, but being late anyway.

...Answering the phone call that's a wrong number—for the 3d time. Or, dialing a wrong number—the same one 3 times.

...Dialing a number of an established business only to have a recording fib, "I'm sorry, the number you have dialed is not a working number."

...Taking notes at a meeting and, suddenly, have all pens run out of ink.

...Taking notes at a meeting when a speaker with 3 minutes worth of information goes for 30 minutes without running out of wind.

...Forgetting your mental note to fill the gas tank until the needle hits "empty".

...Having to kick your way through wastepaper and trash as you walk in front of a place of business.

...Hearing someone repeatedly ask you to explain something when you know darn well he refuses to listen.

...Dropping a coin in a store and watching it roll under a counter.

...Listening to residents complain about their local officials when they have no idea of what those officials are actually doing.

...Watching the Detroit Tigers take 3-out-of-4 from the "big ones" and then blow 4-out-of-4 to bad teams.

"If It Fitz... Funny men in Washington

Editor, Lapeer County Press

By Jim Fitzgerald

Probably the most important step is to get an important job in Washington. The rest follows naturally.

That's my answer to the Woman's Press Club of Indiana. The club invited me to speak at a luncheon meeting in Indianapolis in September. The suggested topic was "The art of being funny."

I won't make the speech, of course, I am still bound by my vow to give no more than I receive. I have been physically unable to sit through an after-dinner speech since 1968 when, at \$100 a plate, Ronald Reagan gave me indigestion that hurt worse than having your legs cut off which is what justifiably happened to Reagan in "Kings Row" (hello there, old movie lovers). So it is only fair that I refuse to verbalize anyone else into the Alka-Seltzer bottle.

BUT THAT doesn't stop me from telling the Indiana press women how to be funny. All they have to do is follow the advice given in the opening paragraph. It is feared that the Washington Monument may someday crumble because of earth tremors set off by the tremendous knee-slappers committed daily in the neighborhood.

For instance, what's funnier than a Secretary of the Air Force who doesn't know what nations his planes are bombing.

Or how about the FBI chief keeping top secret papers in his bedroom, in the middle drawer under his shirts.

But the guy who really aches my sides is Senator Lowell Weicker, the wholesome innocent Republican who keeps saying "DO YOU MEAN TO TELL ME..."

WEICKER thinks it is a dastardly thing that John Ehrlichman and the White House gumshoes should be concerned with the drinking habits of congressmen.

"Constituents at home have no way of knowing that you can go over here in the gallery of Congress and watch a member totter onto the floor in a condition of at least partial inebriation which would preclude

him making any sort of a sober judgement on the issues that confront this country," Ehrlichman said on TV.

(TRANSLATION: Some congressmen come to work drunk.)

Sen Weicker insisted this was no reason for the White House to bug the olive in a congressman's martini. "I am quite satisfied that our system our institutions, are perfectly capable of passing decent judgment, fair judgment on political figures, public officials, without the convert the covert operations of men like Mr Ulasewicz," Weicker said. Ulasewicz is an ex-cop paid by the Nixon team to peek through transoms.

(Translation: if congressmen appear drunk in public, especially in the capital building of the United States, the cop on the beat will deal with them; the same as with any 'Skid Row' bum who might stagger into the joint.)

The rumble you just heard came from the Lincoln Memorial where Abe slapped his knee and started a rockslide.

EVERYONE knows that congressmen police themselves whatever the crime. And Sen Jones wouldn't publicly accuse Sen Smith of being a boozier if Smith passed out in Jones' lap. That's a club rule. Congressmen can accuse each other of all sort of political stupidity and cupidity. But never anything personal. Jones would never suggest that Smith can't legislate effectively because he can't keep from falling off his chair. Because, the next day, Smith might point out that Jones missed 2 committee meetings because he was shackled up with half the stenographic pool.

Does Sen Weicker mean to tell me he didn't know that?

Washington is full of funny men who are always good for laughs. But the people who pay their salaries still can't keep from crying.

1040 U.S. Individual Income Tax Return for the year ending 12-31-1972
Taxpayers Ask IRS

This column of questions and answers on federal tax matters is provided by the local office of the U.S. Internal Revenue Service and is published as a public service to taxpayers. The column answers questions most frequently asked by taxpayers.

Q. In June, my home was damaged by flood. I would have gotten a better tax advantage by deducting my casualty loss on the return I filed in April. Do I have to wait to claim this loss on my 1973 return?

A. If, in 1973, your area was declared a disaster area by the President, and as a result of that disaster, you suffered a casualty loss, you have the option of deducting the loss on your 1972 Federal income tax return or waiting until next year. If you have already filed your return for the prior year, file Form 1040X, which is specifically designed to expedite your refund. For details on how to do it, see IRS Publication 547, "Tax Information on Disasters, Casualty

Losses, and Thefts." Send a postcard to your local IRS office for a free copy.

Q. I've earned more than \$10,000 so far this year. Shouldn't my employer stop withholding social security tax from my pay?

A. The maximum wage base for social security tax withholding in 1973 is \$10,800. This equals \$631.80 in social security tax. After this point, your employer should not be withholding social security tax. If he is still withholding this tax, see him to adjust this over-collection.

Any taxpayer who holds more than one job during the year and has more than \$10,800 of his wages subject to social security tax can claim the excess tax

withheld as a credit against his tax.

Q. I used money from my part-time job to buy new furniture for my bedroom. Will this have any effect on whether or not my parents can claim me as a dependent?

A. No. Capital expenditures for furniture and appliances are not included in total support. As long as your parents contribute more than one-half of your total support and meet all the other dependency tests, they can still claim you as a dependent.

Q. I increased the value of my home by installing central air conditioning. Can I get a deduction for what I spent?

A. No. This expense cannot be deducted, but it can be added to the cost basis of your home. This way, the cost of the air conditioning unit will be taken into account in the event you sell your home.

Real estate course approved for LCC

LANSING -- The Michigan Real Estate Association has announced approval of Lansing Community College's "Real Estate Business II" course as qualifying for participation in the graduate Realtors Institute program.

Real Estate II will begin on October 2nd and meet each Tuesday night from 7 to 10 pm for an eleven week term. Registration for the three-credit course can be

arranged on September 21, 24 and 25.

Each class in Real Estate II will be taught by a well-known member of the Lansing Board of Realtors, including Howard Gladding, vice-president of Simon Realty; Roland J. Ledebuhr, Musselman Realty; Richard Bulder, Abood Realty; Malcolm Milks, Society of Real Estate Appraisers; Harold Halstead, Walter Neller Company; Floyd

Costerisan, Seidman and Seidman; Thomas Bouman, Edward G. Hacker; Roger Pavlik, Roger Pavlik Realty; Art Nelson, Simon Realty.

Real Estate II is the second of three courses required to obtain a Graduate Realtors Institute certificate. LCC also offers Real Estate I and the Real Estate License Examination course.

88th District Report by Stanley Powell State Representative

The state of Michigan is now enjoying a period of economic growth. Favorable national conditions are producing upward trends in many sectors of the state's economy. Increased business activity has enabled Michigan to enact the largest tax cut in its history.

But beneath the facade of these desirable trends lie several basic long-term problems. Studies indicate that this state ranks among the highest in the nation in workmen's compensation and unemployment taxation. On the other hand, Michigan stands 49th in financial incentives offered to industry.

Recent industrial attitude surveys reveal that more than half of this state's major firms would not locate in Michigan if given the opportunity to begin anew. More than one-third of the firms surveyed in the Detroit area advise that they will be leaving Michigan within the next five years.

MOREOVER, only one of Michigan's 27 banks with deposits of more than \$100,000,000 increased its position in national ranking of banks in order of deposits between the end of 1971 and the end of 1972. Only one of the 28 banks of Michigan's top 300 in the industrial centers of Detroit, Flint, Grand Rapids, Kalamazoo, Lansing, Muskegon and Benton Harbor increased in national ranking. The 7.7% deposit growth rate of the 15 Michigan banks in the top 300 in the U.S. is less than half the 16.6% national average for that one-year period.

Accordingly, Michigan cannot delude itself with the superficial manifestations of economic growth and continue to ignore the difficult realities that are causing businesses and major industries to leave this state. Though key economic indications now are strong, they cannot continue unless basic flaws in the fabric of the state's economy are immediately recognized and corrected.

NEW THINGS

If we are to successfully encourage industrial expansion and economic growth, it is crucial for business people to realize that new things are happening in Michigan; that we are prepared to add major new dimensions to state economic opportunity; and that we are ready for new ideas and moving in new directions.

Because it symbolizes a break with our less than effective policies and practices of the past, a "New Michigan" image is imperative for convincing business people going places that Michigan is the place to go.

We face today not an economic crisis but a legislative policy crisis. But unless we move to resolve this legislative policy crisis with effective measures at this time, the real economic crisis will surely follow.

RECOGNIZING these realities, the House Republican Caucus Economic Development Task Force has developed 20 measures designed to create

a more favorable permanent Michigan economic climate. These measures range from financial and tax incentives to business development and municipal bonding authorities to increased tourism promotion and improved labor compensation programs.

They result from a comprehensive study of the economic expansion departments in each of the 50 states and their activities to promote economic developments. They reflect the conviction that a favorable Michigan economy depends too greatly upon success in the automobile industry. Economic diversification must be a paramount goal.

20 PROPOSALS

Of the many possibilities and alternatives considered, priority has been placed on these 20 proposals because they are both attainable and have significant economic impact. There is no instant panacea for every economic dilemma facing this state. They do not address every economic problem. Such solutions—even if conceived—could not be implemented in a single year, for sound economic development is a long-term process.

Rather, these measures provide the structural framework whereby private enterprises may once again operate profitably within the state and expand their operations to meet the increasing job needs of the seventies. They are carefully designed, measured responses to pressing inequities which make Michigan noncompetitive with other states in attracting industry.

Next week, I will discuss our financial incentives recommendations.

NO-FAULT INSURANCE BRINGS EARLIER LICENSE PLATE APPLICATIONS

Don't be surprised if your prepared license plate application arrives in your mailbox in the next few days or maybe you already have received it.

The applications are in the mail right now even though they cannot be used until mid-Autumn when the 1974 license plate tabs go on sale. Applications are being mailed early this year to 300,000 motorists who paid the uninsured motorists fee in connection with a warning effort to inform uninsured

motorists that they've got to start shopping right now for "No-Fault" auto insurance.

EVEN THOUGH uninsured motorists paid the uninsured motorist fee when they purchased their 1973 license plates, they must buy automobile insurance by Oct. 1, when Michigan's new No-Fault law goes into effect.

The penalty for not having insurance is stiff—a \$500 fine—so if you don't have it, you had better start looking for an insurance representative soon.

The remaining five million applications will be sent to motorists who are already insured according to Department of State records.

Motorists who are already insured need do nothing about obtaining "No-Fault" insurance because insurance companies will automatically convert the coverage when the deadline comes.

MOST INSURANCE companies, however, are offering optional coverages and you might want to talk to your agent about them.

GOVERNOR VEToes \$10 MILLION FROM BUDGET BILLS

Free-wheeling legislative spenders can't say that they were not warned of possible vetoes by the Governor. They were and he did. Before signing the school aid bill last week Governor Milliken vetoed provisions worth \$8 million bringing the total amount of vetoes on various bills to close to \$10 million.

The Governor emphasized that this represented only a small portion of the \$45 million the Legislature appropriated over his recommendations and that it would be impossible to cut out the total amount "without the disruptive action of vetoing entire departmental budgets."

Consequently, the Governor has requested that state departments "exercise budgetary controls" within their own priorities and has requested that they hold their spending at approximately 2% below the level of appropriations. The Governor's legitimate concern is that by adopting unnecessarily high budgets this year, we "threaten our capability to adopt responsive and responsible budgets in the next several years, because it would increase the base on which future budgets would be built."

and Mr and Mrs Frederick Van Amburg spent the weekend at Grand Haven last week.

Mr and Mrs Terry Hill and family moved to Cocoa Beach Fla this week. Lisa and Steve Wilson went with them and their parents will go pick them up in two weeks.

Hazel Shaddock spent Saturday and Sunday at Gurnsey Lake with her daughter and family, her granddaughter and son drove her from Maryland last week to visit her parents Mr and Mrs Smith.

Howard Patrick visited Mr and Mrs Herbert Patrick last Tuesday.

The Kenneth Wilsons visited friends in Detroit last weekend and also went to Bob Lo Island.

Mr and Mrs Robert Van Driessen and Pearl Leonard and Mr and Mrs Clifford Leonard visited the Wayne Davison home near Detroit Sunday.

Mrs Hilah Perry and Mrs Leon Gillett and Mrs Charles Higbee visited Betty Smith at the U OF M Hospital Monday.

Mr and Mrs Ernie Seiden

Eagle

NOTICE

Sealed bids will be received by the Clinton County Road Commission, 701 West State Street, St. Johns, Michigan until 10:00 A.M. Monday, September 3, 1973 for the following:

SEASONS REQUIREMENTS OF GASOLINE

Proposals may be obtained at the Clinton County Road Commission office.

The Commission reserves the right to reject any or all bids and award the contract in any manner deemed to be in the best interests of the Road Commission.

CLINTON COUNTY ROAD COMMISSION

Marvin Platte
Paul Nobis
Gerald Lankford

DeWitt township minutes

Synopsis of the Regular Board meeting held on August 13, 1973 at the Township Hall, 780 E Wieland Road, Lansing, Michigan.

The meeting was called to order by Supervisor Emerson at 8:00 p.m.

Board members present: Corr, Purves, Syverson, Emerson, Angell, Kzeski and Pline.

The meeting was opened with the Pledge of Allegiance.

Approved the agenda.

Approved the Board minutes.

Opened the bids for the park shelter and referred this to the Parks Commission.

Approved the agenda.

Approved the Board minutes.

Opened the bids for the park shelter and referred this to the Parks Commission.

The Supervisor reported on the DPW report and meeting.

There was a discussion about the people that have not hooked into the sewer system. Approved the use of a backhoe to check if the connections have been made. Adopted a resolution setting unit factors for tap charges for the sewer system.

Approved paying Hartwick's billing and all vouchers.

Adjournment at 12:50 a.m.

Respectfully submitted, Donna B. Syverson, Clerk.

Approved: Dale S. Emerson, Supervisor.

Referred Ordinance No 23 back to the Police Committee. Voted to have all police vehicles owned by the Township be fully marked within 30 days. Voted to retain Smith as part time. Tabled action on compensation for the acting Chief.

Voted to have Wyble incorporate the recommendations for Ordinance No. 24 in the amendment. Voted to have the base station put in the Fire Department.

Voted to continue with the appeal to the State Tax Commission.

The Supervisor reported on the DPW report and meeting.

There was a discussion about the people that have not hooked into the sewer system. Approved the use of a backhoe to check if the connections have been made. Adopted a resolution setting unit factors for tap charges for the sewer system.

Approved paying Hartwick's billing and all vouchers.

Adjournment at 12:50 a.m.

Respectfully submitted, Donna B. Syverson, Clerk.

Approved: Dale S. Emerson, Supervisor.

Discussed the storm drain billing with Mick and Rowland. They will resubmit a billing.

"Calendar is a gift for the man who has everything, to remind him when the payments are due." (Anonymous)

Agriculture in Action

A recent poll indicated that the number one worry of over 60 percent of the people questioned is inflation's effect on the cost of living. However, inflation is like sin; deplored in word, but practiced in deed. Everybody hates inflation, but loves the things it brings about. Working people hate inflation, but persuade politicians to vote for a higher minimum wage bill. Housewives want a price roll back for meat, but they don't want the empty meat counters that would result. Taxpayers hate high taxes, but love the government benefits these taxes support.

The United States Chamber of Commerce has a "Federal Spending Clock" with rapidly-changing digital figures to indicate how much the government has spent since the beginning of the

fiscal year. On July 1, when the new fiscal year began, they had to reset the clock to run at an accelerated pace to keep up with government spending. The clock's sweeping dial shows \$10,000 spent every 1.17 seconds; a flashing light indicates \$100,000 spent every 11.7 seconds, and a beeping sound means \$1,000,000 spent every one minute and 57 seconds. Each day the clock registers expenditures of approximately \$736 million.

If people, in addition to worrying about inflation, would lay the primary blame at the doors of elected officials responsible for massive government spending, and demand that it be curbed, the battle against inflation could be won.

Farmers, hard-hit by inflation, recognize that the only way federal spending

will decrease is for the majority of taxpayers to insist upon it. Individually and through their organization, Farm Bureau, they have consistently urged government officials to curb excessive and irresponsible federal spending.

They hope other citizens will join them in telling their legislators to slow down the Federal Spending Clock. But, in making this demand, they must realize they can't have their cake and eat it, too. They have to decide whether they hate inflation more than they love cheap dollars.

Tick, flash, beep, goes the clock. Will our elected officials allow it to slow down its headlong speed toward economic disaster? Citizens who diagnose their love-hate syndrome will determine its speed.

DeWitt 4-Her to compete in state tractor contest

DEWITT -- Steven Conklin, 16, took top honors in the Clinton County 4-H Tractor Operators Contest last week. He is now eligible to enter the statewide competition scheduled for August 23 at Michigan State University, according to John Aylsworth, Extension 4-H Youth Agent in St. Johns.

The son of David Conklin and a 4-H member for 7 years, he has completed 5 4-H tractor projects. And, he regularly gets plenty of

driving practice helping operate the Conklin farm. Runner-up in the local event was Duane Haviland, 15, 4540 W Cutler Rd, DeWitt.

In the state wide event, Conklin will be competing for a trip to the eastern US 4-H Tractor and Small Engines Contest to be held at the State Fair of Virginia in Richmond Sept 23-25. Top 4-Hers from 25 states are expected to participate in the 3-day event, which is sponsored by the

Cooperative Extension Service, the Amoco Foundation, Inc, and the National 4-H Service Committee.

Tractor operators will be scored on their abilities to handle a tractor with 2-wheel and 4-wheel vehicles attached, as well as a written exam, safety and troubleshooting.

A trip to Williamsburg and Yorktown and a recognition banquet is also scheduled for all participants and chaperones.



4-PLY TIRES



7.00-13
7.75-14

8.25-14
8.25-15

\$17

ALL SIZES

BLACKWALLS Plus Fed. Ex. tax of \$1.88 to \$2.30 per tire and trade.

LONG MILER WHITEWALLS \$3 more per tire

STEEL BELTED WHITEWALLS

AS LOW AS **\$28** FITS MANY MODELS:

- Gremlin
- Vega
- Pinto
- and many more!

Size A79-13 plus Fed. Ex. tax of \$2.01 per tire and trade.

ATTENTION VW OWNERS

TIRE \$16.95 SALE

BLACKWALLS Size 5.62x15 plus Fed. Ex. tax of \$1.54 per tire and trade.

WHITEWALLS \$3 EXTRA EACH

4 WAYS TO CHARGE
REVOLVING CHARGE
AMERICAN EXPRESS
MASTER CHARGE
BANKAMERICARD

Offers as shown at B.F. Goodrich Stores; competitively priced at B.F. Goodrich Dealers.

HUB TIRE CENTER

Clinton County's Largest Radial Dealer

1411 North US-27
St. Johns
Phone 224-3218

If you want Goodrich, you'll just have to remember Goodrich.



America's Premier Radial Tire Maker

Business and Professional Announcements, Legal News

Probate Court HON. TIMOTHY M. GREEN Judge of Probate HELENA M. BURK Register of Probate

Wednesday, August 29, 1973 Florence I. Bennet - Probate of Will Ina Mae Yeager - Probate of Will Milton Haruska - Claims Ethel B. Pearson - Probate of Will Lucious S. Burnham - Final Account

Real Estate Transfers (From records in office of Register of Deeds)

Aug. 7: Adsit, George S and Laura E to Michael R and Gale Lee Thelen Lot 73, Clinton Village. Aug 7: Dietz, Pauline H to Edward J and Eleanor E Ohren Lot 24, Lake View Farms. Aug 7: Harry, Thomas R and Darlene J to Stanley E and Doris E Bryan property in Sec 10, Bath. Aug 7: Harry, Thomas, R and Darlene J to Stanley E and Doris E Bryan property in Sec 10 Bath. Aug 8: Feldpausch, Reynold H and Karen K to Walter J and Beverly A Rubincan Lot 51 Westwinds No 3. Aug 8: Kobylarz, Joseph and Dorothy E to Alvin and Joanne Mulligan property in Sec 35 Greenbush. Aug 8: Harrington, Leo C and Loretta E to William F Holley and Lunsford R Melvin property in Sec 14 Duplain. Aug 8: Blankenship, Juanita to Russell Cotom Lot 22 Merrylee Est. Aug 8: Ranshaw, Leona to Michael L and Lavonda M Pohl property in Sec 31, Duplain. Aug 8: Nunemaker, Marvin S and Minnie M to Lloyd R and Ardith A Wheeler property in Sec 9 Essex. Aug 8: Nunemaker, Marvin S and Minnie M to Daniel E and Catherine S Carter; Eugene V Metek property in Sec 9 Essex. Aug 8: Abrams, Walter B and Charlotte E to Glenn R and Leatrice J Seifert property in Sec 36 Eagle. Aug 9: Pohl, Carl N and Lillian R. to Roger V and Susan Pohl property in Sec 21 Westphalia. Aug 9: Vance, Bernard and Bertha A to Bernard Weber property in Sec 29 Lebanon. Aug 9: Cutsinger, Roscoe C and Nancy R to Stanley D and Dolores #C Lngeman Lot 10 (Idyl Crest) Est. Aug 9: Kolassa, Jacob F and Carol to Albert and Beverly Grubagh property in Sec 11 Riley. Aug 9: Meisch, Ronald J and Becky L to Harger and Eyke, Inc Lot 30, Viewcrest River. Aug 9: Pocius, B Stanley and Mildred Moldenhauer to Richard and Lois Thompson, Outlot D St Johns. Aug 9: Burgess, John T and Dimis J to Gene D and Mary C O'Connor Lot 21, Hawthorne Hills. Aug 9: Austin, George K and Edna M to Broadmor Apartments property in Sec 13 Ovid. Aug 9: Thelen, Leon E and Bertine A to Tim and Sharon A Bunce property in Sec 7 Greenbush. Aug 10: Bunce, Duane and Leora F to Frederick R and Elizabeth J Denovich property in Sec 15 Greenbush. Aug 10: Berry, Construction Company to David T and Nancy K Bowlin Lot 56 Nelson No 1. Aug 10: Marrison, Ina to Donald D and Margy A Henry property in Sec 11 DeWitt.

Aug 10: Claucherty, Richard Cand Gladys to Don and Sandra F Trantham property in Sec 34 Bath. Aug 13: Gean, Harry L and Josephine to Harvey K Walters Lot 17 Westchester Hghts. Aug 13: Ducharme, Donald R and Marlene to Donald W and Donna J Coon Lot 70, Geneva Shores. Aug 13: Jones, Harold Jr and Eileen to Lenore W Tanous Lot 90, Boichot Acres No 3. Aug 13: Caris, Roger S and Mary L to William Klein property in Sec 29 Lebanon. Aug 13: Paksi, Tom and Mary to Ronald D and Connie J Paksi Lot 14 Blk 29 Ovid. Aug 13: White, John E to Brookridge Construction property in Sec 3 Bath. Aug 13: White, John E to Brookridge Construction property in Sec 3 Bath. Aug 13: Snyder, Clara Christine to Larry R and Carolyn J Thornton Lot 11, 12, Blk 16, Ovid. Aug 13: Grove Bible Church to Robert R and Elsie M Remus property in Sec 9 Victor. Aug 13: Addiss, Jon W and Ruth A to Vernon R and Mattie E Lester property in Sec 20 Victor. Aug 13: Bartig, Vivian E.T. to Ellis B and Helen I Briggs Lot 14, 15 Dumont's add. Aug 13: Briggs, Ellis B. and Helen I to Michael D and Yolanda M Sidel Lot 14, 15 Dumont's add.

Aug 13: Caris, Roger S and Mary L to William Klein property in Sec 29 Lebanon. Aug 13: Paksi, Tom and Mary to Ronald D and Connie J Paksi Lot 14 Blk 29 Ovid. Aug 13: White, John E to Brookridge Construction property in Sec 3 Bath. Aug 13: White, John E to Brookridge Construction property in Sec 3 Bath. Aug 13: Snyder, Clara Christine to Larry R and Carolyn J Thornton Lot 11, 12, Blk 16, Ovid. Aug 13: Grove Bible Church to Robert R and Elsie M Remus property in Sec 9 Victor. Aug 13: Addiss, Jon W and Ruth A to Vernon R and Mattie E Lester property in Sec 20 Victor. Aug 13: Bartig, Vivian E.T. to Ellis B and Helen I Briggs Lot 14, 15 Dumont's add. Aug 13: Briggs, Ellis B. and Helen I to Michael D and Yolanda M Sidel Lot 14, 15 Dumont's add.

Aug 13: Caris, Roger S and Mary L to William Klein property in Sec 29 Lebanon. Aug 13: Paksi, Tom and Mary to Ronald D and Connie J Paksi Lot 14 Blk 29 Ovid. Aug 13: White, John E to Brookridge Construction property in Sec 3 Bath. Aug 13: White, John E to Brookridge Construction property in Sec 3 Bath. Aug 13: Snyder, Clara Christine to Larry R and Carolyn J Thornton Lot 11, 12, Blk 16, Ovid. Aug 13: Grove Bible Church to Robert R and Elsie M Remus property in Sec 9 Victor. Aug 13: Addiss, Jon W and Ruth A to Vernon R and Mattie E Lester property in Sec 20 Victor. Aug 13: Bartig, Vivian E.T. to Ellis B and Helen I Briggs Lot 14, 15 Dumont's add. Aug 13: Briggs, Ellis B. and Helen I to Michael D and Yolanda M Sidel Lot 14, 15 Dumont's add.

LEGAL NOTICES

NOTICE OF MORTGAGE SALE

WHEREAS, default has been made in the terms and conditions of a certain mortgage made by James M. Switzer and Darlene M. Switzer, his wife, of 604 North Clinton Street, St. Johns, County of Clinton, State of Michigan, Mortgage, to Citizens Mortgage Corporation, A Michigan Corporation, 2428 Burton Street, S.E., Grand Rapids, Michigan, Mortgage, dated the 21st day of November, A.D., 1969, and recorded in the Office of the Register of Deeds for the County of Clinton and State of Michigan, on the 25th day of November, A.D., 1969, in Liber 257 of Mortgages on Page 8-10, which said mortgage was thereafter on to-wit: the 17th day of December, A.D., 1969, assigned to the FEDERAL NATIONAL MORTGAGE ASSOCIATION, a Corporation organized and existing under the laws of the United States, and

NOTICE OF MEETING OF DRAINAGE BOARD TO WHOM IT MAY CONCERN:

Notice is hereby given that on the 16th day of July, 1973, a Petition was filed with Richard L. Sode County Drain Commissioner of the county of Ingham asking for the cleaning out, relocating, widening, deepening, straightening, tiling and adding a branch of the Reynolds Drain and Jones Branch. And Whereas the Drainage District of the Reynolds Drain and Jones Branch drain includes lands within the Township of DeWitt County of Clinton, City of Lansing, County of Ingham. And Whereas, a certified copy of said Petition was served upon Dale R. Chapman County Drain Commissioner of the County of Clinton and the Director of Agriculture, by Richard L. Sode County Drain Commissioner of the County of Ingham. Now, Therefore, in accordance with Act No. 40, P.A. 1956, as amended, a meeting of the Drainage Board of said drain will be held at the Emil DeSander Construction Company yard, 321 W. Sheridan Road, in the City of Lansing, county of Ingham, on the 12th day of September 1973, at 10:30 o'clock in the forenoon, to determine the practicalness of said improvement.

Now, Therefore, all persons owning lands liable to an assessment for benefits or whose lands will be crossed by said drain, or any municipality affected, are requested to be present at said meeting, if they so desire.

WHEREAS, no suit or proceedings at law or in equity have been instituted to recover the debt secured by said mortgage or any part thereof, and default having been made whereby the power of sale contained in said mortgage has become operative.

NOW THEREFORE, by virtue of the power of sale contained in said mortgage and pursuant to the Statute of the State of Michigan in such case made and provided, NOTICE IS HEREBY GIVEN that on

MONDAY, the 10th day of September, 1973, at 10:00 o'clock in the forenoon, Local Time, said mortgage will be foreclosed at a sale at public auction to the highest bidder at the front door of the Court House in the City of St. Johns, County of Clinton and State of Michigan (that being the place of holding Circuit Court in said County), of the premises described in said mortgage, or so much thereof as may be necessary to pay the amount due, as aforesaid, on said mortgage with the interest thereon at Seven and one-half (7-1/2%) per cent per annum and all legal costs, charges and expenses, including the attorney fee allowed by law, and also any sums which may be paid by the undersigned, necessary to protect its interest in the premises.

The premises described in said mortgage are as follows: "Lot 9, Block 115, City of St. Johns, Clinton County, Michigan, according to the recorded plat thereof as recorded in frame on wall in the Office of the Register of Deeds, together with an interest in and to the driveway on the South 10 feet of the adjoining lot 10, Clinton County Records."

Take notice that the period of redemption, pursuant to M.S.A. 27A. 3240 shall be 6 months from the date of said sale.

Dated at St. Johns, Michigan, August 1, 1973. FEDERAL NATIONAL MORTGAGE ASSOCIATION, A Corporation organized and existing under the laws of the United States.

Samuel S. Reiter Attorney at Law 115 W. Exchange Street Owosso, Michigan 48867 Telephone 723-8211 15-5

State of Michigan, Department of Agriculture, Drain Section.

NOTICE OF MEETING OF DRAINAGE BOARD TO WHOM IT MAY CONCERN: Notice is hereby given that on the 16th day of July, 1973, a Petition was filed with Richard L. Sode County Drain Commissioner of the county of Ingham asking for the cleaning out, relocating, widening, deepening, straightening, tiling and adding a branch of the Reynolds Drain and Jones Branch.

And Whereas the Drainage District of the Reynolds Drain and Jones Branch drain includes lands within the Township of DeWitt County of Clinton, City of Lansing, County of Ingham. And Whereas, a certified copy of said Petition was served upon Dale R. Chapman County Drain Commissioner of the County of Clinton and the Director of Agriculture, by Richard L. Sode County Drain Commissioner of the County of Ingham.

Now, Therefore, in accordance with Act No. 40, P.A. 1956, as amended, a meeting of the Drainage Board of said drain will be held at the Emil DeSander Construction Company yard, 321 W. Sheridan Road, in the City of Lansing, county of Ingham, on the 12th day of September 1973, at 10:30 o'clock in the forenoon, to determine the practicalness of said improvement.

Now, Therefore, all persons owning lands liable to an assessment for benefits or whose lands will be crossed by said drain, or any municipality affected, are requested to be present at said meeting, if they so desire.

Dated at Lansing, Michigan, this 13th day of August 1973. E. Dale Ball Director of Agriculture By: Stanley R. Quackenbush Deputy Director in Charge of Drains (Inter-County) 17-2

The Eureka Burial Ground Corp. hereby issues notice to the following lot owners at the Eureka Cemetery that unless back assessments are paid action will be taken resulting in forfeiture of all rights to the following lots: Radio Ayers 39D, Beny Austin 17A, Adeline Anderson 31B, Wm. Adams 22A, Leslie Alderfer 42D, Ray Austin 22D, James Andrews 73B, Wm. Bird 11A, Jacob and Ed Brewer 104D, S.C. Barstow 219D, Harrison, E. Barber 197D, Leman Barber 1A, Sarah B in n k 41A, Alex Bushere 10B, Wm. Bussey 27A, John Bussey 14C, P. Barrus 8A, Robt. Barrus 24D, David Bellary 62A, S. Burrows & Mrs. Loren Stevens 39A, Geo. & John Brokawer 56A, Martin Baehleor 60B, Guy Buschert 51B, Burr Dexter 25D, Frank Harvey Brown 21C, Maria Baker 53C, Clayton Brown 64B, James Barrus 68B, Wm. Besley 21A, Kress Benham 14D, Jasper Carpenter 154D, Lloyd Cox 43F, U.G. Carter 228D, Sam Post Crowner 31A, John Cordray 73B, S. Crow & Ruth Dodge 38D, Leo Cox 19B, Sanford Cordray 47A, Geo. Cordray 16C, M.A. Chappell 13C, Chas. Cook 67A, Cath Coverstone 35A, John Coverstone 27B, Laura Case 41D, Kate Cleland 75C, Isaac Coffman - Samuel Case 41C, H.E. Camburn 10A, Lois Dazell 17D, Wm. & Chas. Davis 171D, A. DeWitt 17C, Geo. Daggett 27C, Chas. & Wm. Davis 56C, Willard Dazell 17D, Burr Dexter 25D, Frank Downey 146D, Ruben Daggett 45A, P.M. Dell 76D, DeGifford Elenwood 177D, Mrs. Feeley 263D, C.P. Finch 100D, James Finney 100D, Mrs. J. Freeman 65A, John Foster 65C, Ward Feger 242D, Ray & Oliver Gillespie 55F, James Holmes 64C, S.C. Hollister, J.A. Mrs. M.S. Howes 8C, H.K. Howes 100D, William Innes 47A, Frank Hawkins & Rose Godfrey 3C, Jacob Hill 17B, Ina Hooker 50B, Floyd Coe 90D, Thos. Green 59C, Chas. Calabrese 74D, Daniel Gilson 35A, Clark Gray 28A, Orl Gilson 15A, Chas Grant 10B, Benj. Hawkins 59A, Danus Ingersoll 23B, David Hill 42B, Hattie Holyoke 120D, D. Hayden 55A, C. W. Howes 29 D, Alvin Haway 101D, Vern Huddins 43B, Henry Howard 203D, J.C. Sevy 57C, David Jakeway 70C, Samuel Jeffers 60A, Farnes Jeffers 88A, A. Jackson 104D, Mrs. Wm. Jones 71A, Mrs. Joe Jeffers 66E, James Kirby 72A, Sherman Kirby 85B, Emeline Kirby 14C, Emmet Kirby 38A, O.P. Kirby 23D, John Kirby 38A, J. J. Palmer 272D, Chis. Riddell 141, John Ransom 43C, Mrs. Geo. Hiddle 19C, Sarah Russell 55C, Leroy Russell 32D, Nannie Rupp 48A, Decatur Palmer 74B, Walthon Piersen 31A, Viola Post 74B, Alphonso Pray 10B, E. J. Runtger 17D, Theda Smith 45D, Chas. Tinklepough 92D, Ed Sevy 91D, Florence Strain 210D, Mrs. Ben Stormfeltz 216D, Chas. Sexton 68A, John Shaw 53B, David Sey 10C, Nora Stevens 190D, John Stiles 80C, Wm. Stuart 271C, O. J. Taylor 75C, Wm. Sherman 21A, Isaac Stanley 15A, Wm. Scott 74A, Mrs. Peter Snyder 44A, Harold Saylor 124D, Nathan Spooner 41A, Henry Smith 35B, Chas. Tinklepough 92A, Sarah Thompson 58B, Wm. Thomas 61A, Edwin Tripp 51C, P.S. Trus 25C, J.W. Tracy 52A, Philip Thomas 72C, Thos. Wright 30D, Russell Jesse Perkins 12D, Wm. Williams 217D, W. Williams 216D, Wiliza Weatherby 267D, C. Weatherby Est. 103D, Alonzo Whitney 31D, Mrs. Grant Webber 78C, John Wagner 71A, John Wagner 68A, Mrs. Wm. Wagner 127D, Terry Wright 49D, Lucresia Warden 50C, Mrs. David Walter 98D, Jesse Wheelock 108D, Oscar Wells 224D, R.S. Williams 58F, Elijah Wilkey 16A, Louis Westbrook 20B, Frank Wickes 79B, Garrett Watson 47D, Jacob Wagner 77A.

The Eureka Burial Ground Corp. hereby issues notice to the following lot owners at the Eureka Cemetery that unless back assessments are paid action will be taken resulting in forfeiture of all rights to the following lots: Radio Ayers 39D, Beny Austin 17A, Adeline Anderson 31B, Wm. Adams 22A, Leslie Alderfer 42D, Ray Austin 22D, James Andrews 73B, Wm. Bird 11A, Jacob and Ed Brewer 104D, S.C. Barstow 219D, Harrison, E. Barber 197D, Leman Barber 1A, Sarah B in n k 41A, Alex Bushere 10B, Wm. Bussey 27A, John Bussey 14C, P. Barrus 8A, Robt. Barrus 24D, David Bellary 62A, S. Burrows & Mrs. Loren Stevens 39A, Geo. & John Brokawer 56A, Martin Baehleor 60B, Guy Buschert 51B, Burr Dexter 25D, Frank Harvey Brown 21C, Maria Baker 53C, Clayton Brown 64B, James Barrus 68B, Wm. Besley 21A, Kress Benham 14D, Jasper Carpenter 154D, Lloyd Cox 43F, U.G. Carter 228D, Sam Post Crowner 31A, John Cordray 73B, S. Crow & Ruth Dodge 38D, Leo Cox 19B, Sanford Cordray 47A, Geo. Cordray 16C, M.A. Chappell 13C, Chas. Cook 67A, Cath Coverstone 35A, John Coverstone 27B, Laura Case 41D, Kate Cleland 75C, Isaac Coffman - Samuel Case 41C, H.E. Camburn 10A, Lois Dazell 17D, Wm. & Chas. Davis 171D, A. DeWitt 17C, Geo. Daggett 27C, Chas. & Wm. Davis 56C, Willard Dazell 17D, Burr Dexter 25D, Frank Downey 146D, Ruben Daggett 45A, P.M. Dell 76D, DeGifford Elenwood 177D, Mrs. Feeley 263D, C.P. Finch 100D, James Finney 100D, Mrs. J. Freeman 65A, John Foster 65C, Ward Feger 242D, Ray & Oliver Gillespie 55F, James Holmes 64C, S.C. Hollister, J.A. Mrs. M.S. Howes 8C, H.K. Howes 100D, William Innes 47A, Frank Hawkins & Rose Godfrey 3C, Jacob Hill 17B, Ina Hooker 50B, Floyd Coe 90D, Thos. Green 59C, Chas. Calabrese 74D, Daniel Gilson 35A, Clark Gray 28A, Orl Gilson 15A, Chas Grant 10B, Benj. Hawkins 59A, Danus Ingersoll 23B, David Hill 42B, Hattie Holyoke 120D, D. Hayden 55A, C. W. Howes 29 D, Alvin Haway 101D, Vern Huddins 43B, Henry Howard 203D, J.C. Sevy 57C, David Jakeway 70C, Samuel Jeffers 60A, Farnes Jeffers 88A, A. Jackson 104D, Mrs. Wm. Jones 71A, Mrs. Joe Jeffers 66E, James Kirby 72A, Sherman Kirby 85B, Emeline Kirby 14C, Emmet Kirby 38A, O.P. Kirby 23D, John Kirby 38A, J. J. Palmer 272D, Chis. Riddell 141, John Ransom 43C, Mrs. Geo. Hiddle 19C, Sarah Russell 55C, Leroy Russell 32D, Nannie Rupp 48A, Decatur Palmer 74B, Walthon Piersen 31A, Viola Post 74B, Alphonso Pray 10B, E. J. Runtger 17D, Theda Smith 45D, Chas. Tinklepough 92D, Ed Sevy 91D, Florence Strain 210D, Mrs. Ben Stormfeltz 216D, Chas. Sexton 68A, John Shaw 53B, David Sey 10C, Nora Stevens 190D, John Stiles 80C, Wm. Stuart 271C, O. J. Taylor 75C, Wm. Sherman 21A, Isaac Stanley 15A, Wm. Scott 74A, Mrs. Peter Snyder 44A, Harold Saylor 124D, Nathan Spooner 41A, Henry Smith 35B, Chas. Tinklepough 92A, Sarah Thompson 58B, Wm. Thomas 61A, Edwin Tripp 51C, P.S. Trus 25C, J.W. Tracy 52A, Philip Thomas 72C, Thos. Wright 30D, Russell Jesse Perkins 12D, Wm. Williams 217D, W. Williams 216D, Wiliza Weatherby 267D, C. Weatherby Est. 103D, Alonzo Whitney 31D, Mrs. Grant Webber 78C, John Wagner 71A, John Wagner 68A, Mrs. Wm. Wagner 127D, Terry Wright 49D, Lucresia Warden 50C, Mrs. David Walter 98D, Jesse Wheelock 108D, Oscar Wells 224D, R.S. Williams 58F, Elijah Wilkey 16A, Louis Westbrook 20B, Frank Wickes 79B, Garrett Watson 47D, Jacob Wagner 77A.

Notice is hereby given that on the 16th day of July, 1973, a Petition was filed with Richard L. Sode County Drain Commissioner of the county of Ingham asking for the cleaning out, relocating, widening, deepening, straightening, tiling and adding a branch of the Reynolds Drain and Jones Branch.

And Whereas the Drainage District of the Reynolds Drain and Jones Branch drain includes lands within the Township of DeWitt County of Clinton, City of Lansing, County of Ingham. And Whereas, a certified copy of said Petition was served upon Dale R. Chapman County Drain Commissioner of the County of Clinton and the Director of Agriculture, by Richard L. Sode County Drain Commissioner of the County of Ingham.

Now, Therefore, in accordance with Act No. 40, P.A. 1956, as amended, a meeting of the Drainage Board of said drain will be held at the Emil DeSander Construction Company yard, 321 W. Sheridan Road, in the City of Lansing, county of Ingham, on the 12th day of September 1973, at 10:30 o'clock in the forenoon, to determine the practicalness of said improvement.

Now, Therefore, all persons owning lands liable to an assessment for benefits or whose lands will be crossed by said drain, or any municipality affected, are requested to be present at said meeting, if they so desire.

WHEREAS, no suit or proceedings at law or in equity have been instituted to recover the debt secured by said mortgage or any part thereof, and default having been made whereby the power of sale contained in said mortgage has become operative.

NOW THEREFORE, by virtue of the power of sale contained in said mortgage and pursuant to the Statute of the State of Michigan in such case made and provided, NOTICE IS HEREBY GIVEN that on

CITY COMMISSION MEETING MINUTES

July 23, 1973 Mayor Wood called the regular meeting of the City Commission to order at 7:30 pm.

Comm Present: Grosz, Hannah, Ebert, Rand, Wood. Staff Present: City Manager, City Clerk, City Attorney, Zoning Administrator.

Motion by Comm Hannah, supported by Comm Ebert, to amend the minutes of July 9, 1973. Further, to adopt the minutes of July 2, 1973 and the amended minutes of July 9, 1973. Motion carried.

Motion by Comm. Grosz, supported by Comm. Rand, to approve the warrants. Motion carried.

Mayor Wood read the proposed agenda. Motion by Comm Grosz, supported by Comm Rand, to approve the agenda. Motion carried.

The Searles' Board of Appeals application. Further, to request the Board of Appeals to delay consideration of the request until the information is available. Motion carried.

Major Wood read a proclamation in regards to the Jaycees. "Funds-A-Poppin' Popcorn Week."

Motion by Comm Ebert, supported by Comm Grosz, to allow the Boy Scouts, Cub Scouts and Jaycees to sell popcorn in St Johns and to waive any fees required by City ordinance. Motion carried.

General discussion regarding the communication from the Tri-County Emergency Medical Services followed.

Motion by Comm Grosz, supported by Comm Rand, that the City of St Johns resolve to support the Tri-County Emergency Medical Services in their grant efforts, however, stipulating that there be no financial participation by the City of St Johns. Motion carried.

A Planning Commission recommendation was presented to the City Commission for consideration regarding denial of the Prince Rezoning request.

Motion by Comm Ebert, supported by Comm Wood, to accept the Planning Commission recommendation. YEA: Wood, Ebert, NAY: Grosz, Rand, Hannah.

Motion failed. Motion by Comm Grosz and Comm Rand to ask the Planning Commission to delay further consideration of the Prince request, pending further requests by Mr Prince for rezoning. Motion carried.

The City Manager reported in regard to the Sullivan farm water line that he could not make a recommendation for the water line until plans were received.

Motion by Comm Ebert, supported by Comm Rand, to table the water line request until the next meeting. Motion carried.

Mr W. Searles presented the preliminary plats for Morton Estates.

Motion by Comm Rand, supported by Comm Grosz, to authorize tentative approval of the preliminary plat of Morton Estates No 1. Motion carried.

The City Manager presented paving bids. The City Manager recommended that the City Commission accept the low bid of Spartan Asphalt Co.

Motion by Comm Grosz, supported by Comm Ebert to accept Spartan Asphalt Co's bid. Motion carried.

The City Manager presented concession stand bids.

Comm Hannah asked if Cornwell Constr Co had completed the other city job which has been awarded to them.

The City Manager informed Comm Hannah that the curb repair work for N Clinton Ave had not been completed.

Motion by Comm Ebert to accept the low bid of Cornwell Constr Co. Motion failed for lack of support.

Motion by Comm Hannah, supported by Comm Grosz, that the award for the bid be withheld from Cornwell Constr Co until we get an agreement which stipulates a 60 day completion date for both projects. Motion carried.

The City Manager presented the City Commission with a communication from Miller, Canfield, Paddock and Stone, the City's bonding attorneys regarding bond issues.

Motion by Comm Rand, supported by Comm Wood to accept the recommendation of Miller, Canfield, Paddock and Stone, and to set a special meeting which will be held at 12:15 pm, July 30, 1973, to review the ballot bond issue question.

YEA: Rand, Grosz, Wood, Ebert. NAY: None ABSTAINED: Hannah Motion carried.

Motion by Comm Eberf, supported by Comm Hannah to adopt temporary Traffic Control No 43-73 as permanent. Motion carried.

supported by Comm Ebert that the petition be sent to the City Manager for recommendation. Also, to stipulate that the street not be paved until it is clear whether or not the sewer would be built. Motion carried.

Comm Rand told the City Comm that she had received several calls from area mothers regarding the city ordinance which does not allow bicycle riding on city sidewalks, yet they couldn't ride on business streets. She suggested that the city provide bike racks somewhere near the courthouse.

Motion by Comm Rand, supported by Comm Grosz that the City Manager write a letter to the Courthouse and Railroad Co to see if it would be possible to place bike racks on their properties. Motion carried.

Motion by Comm Rand supported by Comm Hannah that after all Zoning Board of Appeal meetings and Planning Commission meetings, copies of their minutes be put in the City Commission packet. Motion carried.

Motion by Comm Hannah, supported by Comm Grosz, to adjourn. Motion carried. Meeting adjourned at 9:12 pm.

Huntington attends banking school

MADISON -- Charles Huntington, of the Clinton National Bank and Trust Co., St. Johns, was among 1,025 banker-students from 50 states, Washington, D.C., Honduras, Puerto Rico, and the Virgin Islands who attended the 21st summer session of the 3-year school for Bank Administration held July 22-August 3 at the University of Wisconsin at Madison.

The record 1025 banker students included 56 women.

They came from states ranging from Alaska to Florida and Rhode Island to California. The total included 413 freshman students, 348 juniors, and 264 seniors.

The school is sponsored by the University of Wisconsin and the Bank Administration Institute, and is one of the more than 500 short courses and conferences held on the Wisconsin campus at Madison throughout the year.

Wacousta MRS. EDWARD KRAFT Ph. 620-0844

Wacousta OES Past Matrons and Patrons will hold a picnic Sunday Aug 26 at 1 o'clock at Richard Rosier's Cottage at Crystal Lake.

Willing Workers Circle will meet Thursday evening Sept 6 at 7:30 pm with Mrs Robert Nourse on Grand River.

There is to be a fall auction. Wacousta Circle will meet Thursday Sept 6 for a 12:30 luncheon with Mrs Paul Garlock.

Mr and Mrs Richard Rosier, Mr and Mrs Earl Rosier and Mrs Ed Kraft attended the memorial service of their uncle and cousin, Leo Rosier Friday in Lansing.

Mr and Mrs Forrest Shipman entertained their Bridge Club Saturday evening.

Mr and Mrs J.C. Fuday and Mr and Mrs Ed Kraft spent a couple of days with Mr and Mrs Fred Black at their cottage at Horseshoe Lake.

Congratulations to Mr and Mrs Charles Walker who were married Saturday. They will live in the Brace Apartment.

Mr and Mrs Gorden Halmgren of Superior, Wis, were Wednesday night guests of Mr and Mrs Edwad Kraft.

Veau Friday of Grand Rapids called on the Jay Friday family Wednesday. Mrs Harriet Beach and family spent last week at Pentwater State Park. Mrs Loyal Chamberlin and Marlene spent the day with them Thursday.

Mrs Cecil Stevens, Mrs J.C. Friday, Mrs Lester Garlock, Mrs Fred Black and Mrs Ed Kraft were Tuesday luncheon guests of Nancy Kraft in Grand Rapids.

Plan to attend the chicken bar-be-que at the Looking Glass Valley Park in Wacousta, Labor Day Sept 3. Games for children and adults in the afternoon.

Table with columns: DEPARTMENT OF THE TREASURY, OFFICE OF REVENUE SHARING, 1800 PENNSYLVANIA AVE N.W. WASHINGTON, D.C. 20226. Includes sections for DEBT, TAXES, OPERATING/MAINTENANCE EXPENDITURES, and CAPITAL EXPENDITURES.

Table with columns: DEPARTMENT OF THE TREASURY, OFFICE OF REVENUE SHARING, 1800 PENNSYLVANIA AVE N.W. WASHINGTON, D.C. 20226. Includes sections for DEBT, TAXES, OPERATING/MAINTENANCE EXPENDITURES, and CAPITAL EXPENDITURES.

Table with columns: DEPARTMENT OF THE TREASURY, OFFICE OF REVENUE SHARING, 1800 PENNSYLVANIA AVE N.W. WASHINGTON, D.C. 20226. Includes sections for DEBT, TAXES, OPERATING/MAINTENANCE EXPENDITURES, and CAPITAL EXPENDITURES.

Business Directory with sections for AUTOMOTIVE, FARM SERVICES, HARDWARE, GOWER'S HARDWARE, GRAIN ELEVATOR, BOTTLED GAS, CREDIT BUREAU, INSURANCE, and FARM DRAINAGE.

Results of Clinton County 4-H fair

Tractor

Group A
Chris Haviland, Duane Haviland, Christopher Horak, Joseph Horak, Jay Miller, Louis Simon, Kevin G Thelen, Douglas White.

Group B
Rick Batora, Dane Bauer, Aron Whitaker, Pat Zeeb.

Small Engines
Group A
Lynford Bradley, Gary Brook.

Group B
Rick Alward, Dale Burnham, Bill Hamsey.

Snowmobile
Group A
Jeff Crandall, Chris Howe, Kim Howe, Spencer Maris, Jeff Wagner, Darlene Wilson.

Group B
David Baseo, Glen Baseo, Paul Howe, Sally Howe, Starr Lough, Jamie McE, Jerry Price, Patrick Purfill, Jeff Wagner, Kevin Wilson, Cindy Wohlfert.

Group C
Scott Wohlfert.

VEGETABLES - Junior

Group A
Douglas Acre, Rodney Acre, Terry Ballinger, Mary Bergdoll, Barry Brown, Dale Burnham, Todd Curtis, Bruce Davis, Donna Davis, Douglas Davis, Julie Day, Lisa Day, David Dennis, Sandra Fedewa, Jane Hafner, Dexter Hughson, Bill Huguelet, Martell Magrin, Rose Miller, Julie Platte, James Pohl, Gayla Risley, Lynette Risley, Bonnie Rossow, Terry Schike, Tracy Schike, Armond Smith, Rodney Sney, Jeanne Spitzley, Michelle Steger, Brian Thelen, Jeff VanVleet, Mark Wells, Darlene Wilson, Terry Witt, Bruce Rossow, Marshall Baker, Bobette Sascoe, Jan Barz, Shawn Curtis, Randy Dilday, Mark Hebeck, Chris Howe.

Group B
Lucy Arcs, Pamela Cramer, Gerilyn Falvor, Allan Howard, Lawrence Janderanna, John Richmond, Randy Ward, Debbie White.

Group C
Allen Flowman.

VEGETABLES - Senior

Group A
Brian Acre, Tonya Acre, David Baseo, Helen Blakely, Brenda Geisenhaver, Dawn Geisenhaver, Tamra Harris, Annette Irish, Cheryl Hudemacher, Roseanne Rossow, Steve VanVleet, Brian Walsh, Mark Walsh.

Group B
Michele Huynes, Cindy Ortiz, David Pohl.

Commercial

Group A
Ed Falvor, Frank Falvor, Debbie Hurst, Clarice Krebich, Alan Lane, Jay Miller, Nick Pytlowany, Steven Pydlowany, Jerry Smith, Bernice Sullivan, Brad VanVleet, Brian VanVleet, Jeff Vesmeersch, James Williams, Penny Krebich, Jean Divine.

Educational

Group A
Kathy Valentine, 4-Corners 4-H Club.

VETERINARY SCIENCE

Group A
Karin Barnes, Keith Bradley, Julie Chant, Ruth DeBoer, Lisa Spitzley.

Group B
Carla Bergan, Jana Bergan, Chrissie Chang, Diane DeBoer, Cindy Exelby, Kim Bartin, Jane Speers, Tracy Speers, Daniel Witt, Terry Witt.

Group C
Eric Bergan.

Electrical Science - Beginner

Group A
David Baert, Ronald Bauerle, Steve Eaton, Christopher Horak, Joseph Horak, Gerald Rademacher, Kurt Slamka, Jim Thelen, Aron Whitaker, Douglas White, Leslie Vitezke.

Group B
Gary Brook, Dale Burnham, Gary Reeves, David Schrader.

Group C Barry Brown.

Electrical Science - Junior
Group A
David Rice, Gary Slamka, Douglas Thelen.

Group B
Daniel Rademacher, Gary Schafer, Brad VanVleet.

Electrical Science - Senior
Group B
Ed Falvor, Mark Fedewa, Brian VanVleet.

WOODWORKING The Apprentice

Group A
Paul Adams, Brenda Bancroft, Garth Banninga, Teresa Barker, Barry Bernath, Denise Cerny, Tyann Cobb, Loren Conklin, Beth Cowan, Robert Davis, Jeff DeBrabander, William Dillingham, Bobby Epton, Steve Eaton, Michael Eldridge, Joseph Esch, Chris Fairchild, Larry Falvor, Daniel Fedewa, Karen Fedewa, Ruth Fedewa, Andrew Feldpausch, Debbie Geller, Daniel Halstead, Richard Harmon, Maurice Harvey, Mark Hebeck, Christopher Horak, Terry Howard, Jeff Howe, Eton Huqangel, Christopher Palmiter, Matthew Palmiter, Larry Peterson, Robert

Group B
Pung, Gerald Rademacher, Scott Rossow, Terry Schafer, David Scharder, Ronnie Scharder, Scott Shiebel, Korte St Johns, John Swagart, Brian Thelen, Jim Thelen, Kevin G Thelen, Mike Thelen, Timothy Thelen, Andy Todoseuk, Harry Volinet, Wesley Ward, Kevin Wilson, David Witt, Peter Witteveen, Brent French, Ron Telling.

Group B
David Baert, Rick Batora, Scott Bauman, Sally Buggs, Kevin Howard, Calvin Rice, Morrie Roberts, Mark Slowinski, Chris G Thelen, Douglas White, Jeffrey Winars, David Eport.

Handyman

Group A
Jonathan Barz, Barrett Blaylock, David Dennis, Steve Dunigan, Frank Harmon, Brian Hazle, Joseph Horak, Steve Eaton, Paul Howe, William Lehman, Rodney Lounda, Steve Malkin, David Messer, Bruce Orweller, Kevin Palmiter, Michael Palmiter, Patrick Radtill, Anne Rademacher, Daniel J Rademacher, David Rice, Jeffrey Rice, Gary Schafer, David Schike, Tracy Schike, Jim Shafley, Paul Simon, Rodney Sney, Sue Ann Suchek, Douglas Thelen, Daniel Witt, Terry Witt.

Group B

Jeff Bollinger, Bruce Davis, Douglas Davis, Mark Fongers, Mark Grennell, Dexter Hughson, Mike Hurst, Kenneth Laskaway, Jay Miller, Victor Rensberry, Bruce Schafer, Bob Boisinet, Don Gladstone, John Richmond.

Craftsman

Group A
Timothy Barz, Frank Falvor, Mark Fedewa, Earl Flegler, Jr, Duane Haviland, Greg Hazle, William Harman, Dorella Marten, Gerald, Minarik, Ron Presocki, Daniel G Thelen, Rodney Thornton, Jim Vermesech, Michael Wilson, Michael Simon.

Group B
David Baseo, Dennis Baseo, Steven Conklin, Lance Parmelee, Bruce Rossow.

Group C
Ed Falvor, Robert Gladstone.

DEMONSTRATION CONTEST

Group A
Harry Bernath, Harry Moldenhauer, Joanne Seeger.

Group B
Brenda Bancroft, Debbie Thelen.

ACTION EXHIBIT CONTEST

Group A
Kristine, Aylsworth, Lisa Foy, Douglas Thelen.

LITTER BARRELS

Group A
Bengal Community, Fowler Busy Bees, Olive's 4-H Projects, Tall Waggers, Victor 4-H, Bath All Purpose, Maple Leaves.

Group B
Boots & Buckles, Nimble Fingers, Prairie 4-H, Stoney Creek, Trail Breakers, Riverside Riders.

Group C
Four Corners, Orchard Glen.

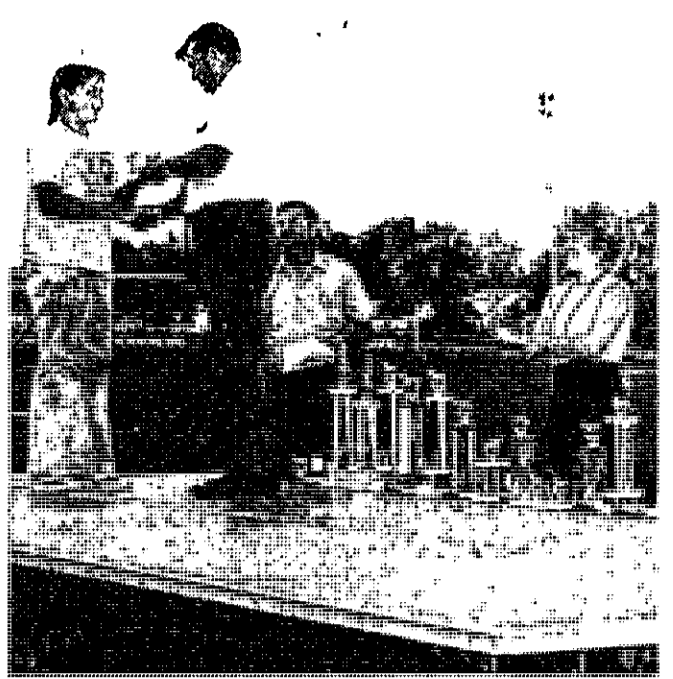

Karen Green - Jr. Dairy Showmanship

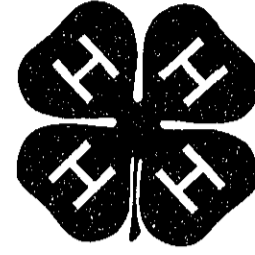

Food A series explaining "how much" and why Stepping Stones to Savings

Main-dish menu planning takes a large portion of each food dollar. To economize on these foods, you'll want to do comparative shopping and employ the 2 cornerstones of selective protein buying and managing.

THE FOLLOWING protein buying tips can revitalize your ailing meat budget.

- Buy meat according to the number of servings per pound rather than cost per pound.
- Use less tender cuts of beef for cooked meat dishes.
- Select frozen, canned or fresh fish, poultry or pork according to price advantages.
- Substitute 3 ounces of cooked lean meat from the following sources:

- 2 eggs
- 1 cup cooked dry beans
- 1 oz natural cheese
- 2/3 cup cottage cheese
- 4 tablespoons peanut butter

2-1/4 cups fluid milk
1 cup fluid milk plus 5 tsp. dry milk powder

Buying advantageously is one step toward economizing on the escalating food dollar, but managing your food investments in your kitchen will extend your savings.

- Stretch meat, poultry, and fish with pasta products; fresh, frozen or dried vegetables; breads and cereals.
- Use herbs, sauces and seasonings to perk up flavors.
- Freeze extra servings of combination dishes.
- Cook large quantities of rice, dry beans or dry peas and freeze remaining amounts in quantities suitable for future recipes.
- Plan menus around seasonal foods and specials.
- Supply your own labor of shredding, slicing and grating.

Substitute homemade white sauce for canned soups.

THESE SMALL pebbles of suggestions, when carried out, can make a substantial saving to your food dollar. Remember the 2 stepping stones, of buying and management tips, are made up of the small things of life done consistently over a period of time. For example homemade white sauce costs one-half as much as condensed cream soups and only takes 4 minutes to prepare. Start up the ladder of successful saving by substituting medium white sauce for condensed soups in the following penny pinching maindish recipes.

PERFECT WHITE SAUCE

Thin
For creamed vegetables, soup base
Butter 1 Tbsp
Flour 1 tsp
Salt 1/4 tsp
Pepper 1/8 tsp

Milk 1 cup
Medium
For creamed & scalloped dishes

Butter 2 Tbsp
Flour 2 Tbsp
Salt 1/4 tsp
Pepper 1/8 tsp
Milk 1 cup
Thick
For croquette & souffles
Butter 1/4 cup
Flour 1/4 cup
Salt 1/4 tsp
Pepper 1/8 tsp
Milk 1 cup
Melt butter over low heat in heavy saucepan. Wooden spoon for stirring is a help. Blend in flour, seasonings. Cook over low heat, stirring until mixture is smooth and bubbly. Remove from heat. Stir in milk. Bring to boil, stirring constantly. Boil 1 minute. Add a bouillon cube for chicken flavor, grated cheese for cheese soup, or use 1/4 cup mushroom liquid and 3/4 cup of milk plus mushroom pieces for mushroom soup.

Headquarters For Purina Feeds & Animal Health Products

TEST DRIVE
THE '73s
NOW!

Chevrolet Caprice
Jim Edinger Chevrolet
Fowler

ALWAYS IN THE MARKET FOR
• Oats • Corn • Wheat • Soybeans
• White Beans
Sell, Store, or Grain Bank
BULK AND BAGGED FERTILIZER
AND BULK DELIVERY OF PURINA FEEDS
MATHEWS ELEVATOR
Fowler, Mich. Ph. 593-2111

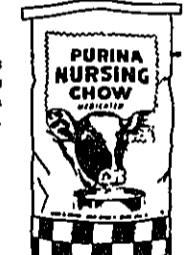
PLUMBING AND HEATING
*RESIDENTIAL * COMMERCIAL
*QUALITY WORK
DUNKEL
PLUMBING & HEATING
St. Johns

1
From 4 days thru 4 weeks
Feed Purina Nursing Chow.

2
From 4 days thru 2 months
Food Purina Calf Startona.

3
From 2 thru 6 months
Now Purina Calf Growena.

PURINA DAIRY SPRAYS help you save money by controlling flies. Cows eat more, rest more, milk more—make more money for you. Get quick kill and long-lasting action. Fly control pays. See us soon for the right Purina Dairy Spray to fit your needs.

Purina Fly Bait

Scatter it where flies gather. It attracts houseflies, kills even resistant strains quickly. Long-lasting and low-cost, it's safe and easy to use. Get Purina Fly Bait in the big 10 or 25 pound bag—priced for low-cost farm use.

FLY PROTECTION



the PURINA way

MATHEW'S Elevator
PURINA CHOWS FOWLER PURINA HEALTH PRODUCTS

No job is too large or too small for CAINS COMPLETE
AUTO BODY
Any Make-Any Model
Bumping-Painting-Reconditioning the finest workmanship makes it look like new.
CAINS Inc.
210 Higham St. Johns 224-323T

EVERYTHING FOR THE SOIL

St. Johns - 224-3234 Ashley - 847-3571
VIRGIL ZEEB

MOORE OIL CO.

Charge your purchases to:
ST. JOHNS Ph. 224-4726

1/2 OFF All Party Goods, Candles, Gift Items
NEW SHIPMENT Posters, Puzzles, Gift Items
Beautiful WOOD GIFT ITEMS
236 N. Clinton
Russell Stover
CANDY

Federal LAND BANK Association
SEE US FIRST FOR FARM LOANS
• New Facilities?
• Repairs?
• Expansion?
• Modernization?
1104 S. US-27
Ph. 224-7127
St. Johns, Mich.
Serving America's Farmers: Providers of Plenty

Distinctive PRINTING
When Time Means Money
We can save you both. We'll meet your deadline and save you money.
CALL US NOW!
Clinton County News

Photo highlights of 4-H fair



Wobster - Under 6 months



Ann Graham - Over 6 months

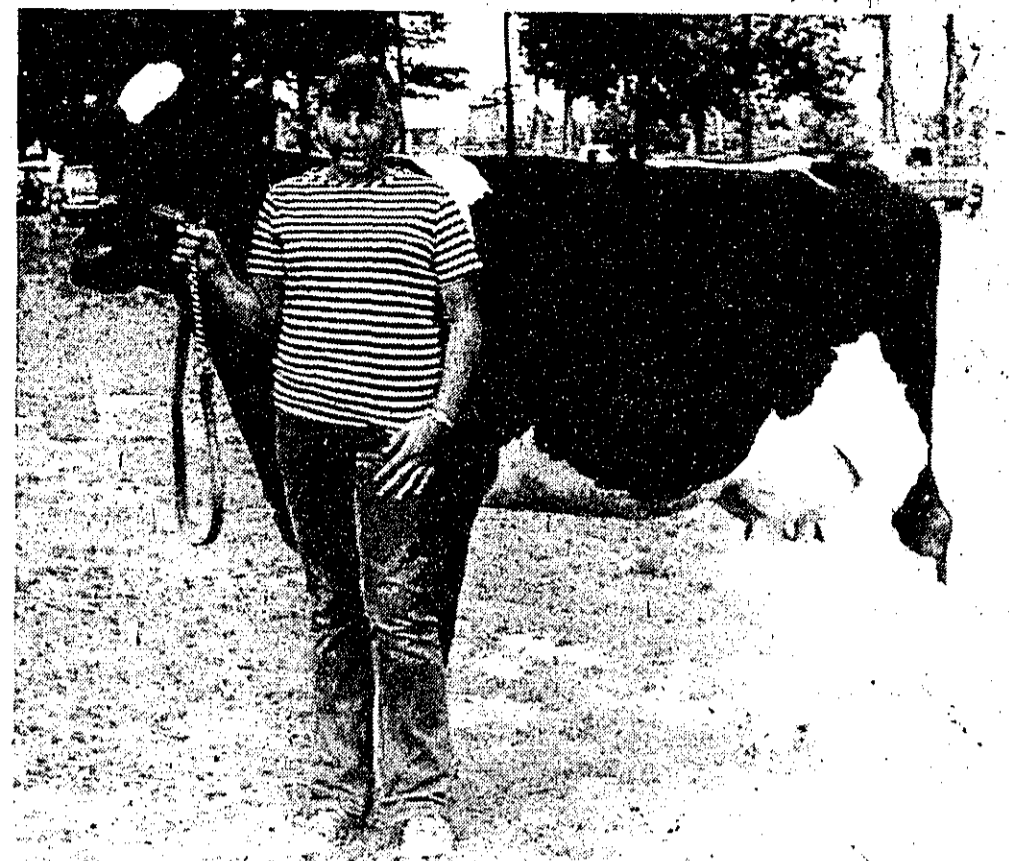

Karen Green - Junior Showmanship Dairy



Jeanne Striz - Senior Dairy Showmanship



Linda Wessler - Jr. Miss Clothing Rosette



Jeanne Striz - Dairy Showmanship

See your friendly Ford dealer...

“HE WANTS TO MAKE YOU HAPPY”

EGAN FORD SALES

200 W. Higham St. ST. JOHNS Phone 224-2285

LP GAS A FUEL for ALL SEASONS

NO MATTER WHAT YOUR NEEDS - LP GAS WILL DO THE JOB!

Prompt Delivery 6560 S. Begole Rd. PERRINTON
1/2N - 2W - 1/2 N From Pompeii PHONE POMPEII
WHITE'S GAS 838-2201

MINI-PRINT by **PRINTCO**
120 E. WALKER ST.
Across from the St. Johns City Hall

ALL TYPES OF PRINTING

Fast Service! Low Prices!

- ★ Wedding Invitations ★ Lodge Programs
- ★ Service Club Bulletins ★ Business Cards
- ★ News Letters ★ Envelopes ★ Letterheads
- ★ Invoices ★ Statements ★ Scratch Pads
- ★ Direct Mail Pieces ★ Sale Bills ...

and more!

Friendly Experienced People at a convenient location...
120 E. Walker St. Across from the St. Johns City Hall
Phone 224-6781

THE GOVERNMENT OF RILEY TOWNSHIP
PLANS TO EXPEND ITS REVENUE SHARING ALLOCATION FOR THE ENTITLEMENT PERIOD BEGINNING

DEPARTMENT OF THE TREASURY
OFFICE OF REVENUE SHARING
1500 PENNSYLVANIA AVE. N.W.
WASHINGTON, D.C. 20528

JUL 1, 1973 AND ENDING JUN 30, 1974
IN THE FOLLOWING MANNER BASED UPON AN ESTIMATED TOTAL OF \$4,774

ACCOUNT NO. 22 3 013 013
RILEY TOWNSHIP TOWNSHIP TREASURER CLINTON COUNTY 6612 N PRICE RD ST JOHNS MICH 48873

EXECUTIVE PROPOSAL: Check this check if this plan is based on an executive proposal.

(I) DEBT How will the availability of revenue sharing funds affect the borrowing requirements of your jurisdiction?
 AVOID DEBT INCREASE NO EFFECT
 LESSEN DEBT INCREASE TOO SOON TO PREDICT EFFECT

(II) TAXES In which of the following manners is it expected that the availability of Revenue Sharing Funds will affect the tax levels of your jurisdiction? Check as many as apply.
 WILL ENABLE REDUCING RATE OF A MAJOR TAX WILL REDUCE AMOUNT OF RATE INCREASE OF A MAJOR TAX
 WILL PREVENT ENACTING A NEW MAJOR TAX NO EFFECT ON TAX LEVELS
 WILL INCREASE RATE OF A MAJOR TAX TOO SOON TO PREDICT EFFECT

PRIORITY EXPENDITURE CATEGORIES (A)	PLANNED EXPENDITURES (B)	PERCENT PLANNED EXPENDITURES (C)	PERCENT AVAILABLE FUNDS (D)	PERCENT UNMET NEEDS (E)	PURPOSE (F)	PERCENT PLANNED FOR:			
						PLANNED EXPENDITURES (G)	EQUIPMENT (H)	RENTALS (I)	RETIRES (J)
PUBLIC SAFETY	\$	%	%	%	10 PUBLIC SAFETY AND GENERAL GOVT.	%	%	%	%
ENVIRONMENTAL PROTECTION	\$	%	%	%	11 EDUCATION	%	%	%	%
PUBLIC TRANSPORTATION	\$ 4,774.00	100	96	4	12 HEALTH	%	%	%	%
HEALTH	\$	%	%	%	13 TRANSPORTATION	%	%	%	%
RECREATION	\$	%	%	%	14 SOCIAL DEVELOPMENT	%	%	%	%
LIBRARIES	\$	%	%	%	15 HOUSING & COMMUNITY DEVELOPMENT	%	%	%	%
SOCIAL SERVICES FOR AGED & POOR	\$	%	%	%	16 ECONOMIC DEVELOPMENT	%	%	%	%
FINANCIAL ADMINISTRATION	\$	%	%	%	17 ENVIRONMENTAL CONSERVATION	%	%	%	%
TOTAL PLANNED FINANCE EXPENDITURES	\$ 4,774.00				18 PUBLIC SAFETY	%	%	%	%
(III) ASSURANCES (Refer to Instruction G)					19 RECREATION & CULTURE	%	%	%	%
					20 OTHER/SPECIFY	%	%	%	%
					21 OTHER/SPECIFY	%	%	%	%
					22 OTHER/SPECIFY	%	%	%	%
					TOTAL PLANNED CAPITAL EXPENDITURES				

The news media have been advised that a complete copy of this report has been published in a local newspaper of general circulation. I have records documenting the contents of this report and they are open for public and news media scrutiny.

I assure the Secretary of the Treasury that the statutory provisions listed in Part G of the Instructions accompanying this report will be complied with by this recipient government with respect to the entitlement funds reported herein.

Sharon M. Thelen 8-19-73 Clinton County News
North St. Johns Supervisor 8-22-1973
NAME & TITLE - PLEASE PRINT DATE FORWARDED



Next Sunday in Clinton County churches

All Churches in Clinton County are invited to send their weekly announcements to The Clinton County News. They must reach us by 10 a.m. Monday to insure publication in the current week's issue.

FIRST CONGREGATIONAL CHURCH
Averill M. Carson, Minister
Sunday, August 26
10:00 am Morning Worship
Wednesday, August 29
6:45 pm Boy Scout Troop No. 81

UNITED METHODIST CHURCH
Rev Francis C. Johannides - Minister
Worship - 10 am

FIRST BAPTIST CHURCH
South US-27
Paul A. Travis, Pastor
9:45 am Bible School
10:35 am Worship Service
11 am Children's Church
6 pm W.T.U.M. and U.T.M.E.
7 pm Evening Worship
8:00 pm Church Training
8:00 pm Evening Worship

Each Wed 7 pm The Hour of Power for the whole family. 8 pm Choir practice.
8:00 pm - Choir Practice - Jr. Basketball
First Sunday-Communion Service
First Tuesday-Deacons' Meeting
Second Tuesday-Ladies' Missionary Circle.
Mon-Fri "Moments of Meditation."
9:15 am Radio WRBJ
Church office hours
9-12 & 1-3 Mon thru Fri

ST JOHN'S EPISCOPAL CHURCH
Corner of Mead and Walker
Rectory 405 E Walker
Phone 224-2800
Office 224-2885

1973 Schedule
Every Sunday 8 am Holy Communion.
2d & 4th Sunday 10 am Holy Communion and Sermon
Other Sundays - 10 am - Morning Prayer and Sermon
Nursery & church school 10 am for nursery through 6th
Every Monday eve 7 pm - Spiritual Healing Service
1st & 3rd Mondays 7 pm Senior Citizens
2d & 4th Tuesday - Noon - Senior Citizens
Every Tuesday morning and evening youth watchers
2d Wednesday 1-5 pm Family Planning Clinic
1st & 3rd Wed morning OEO Nutrition Class
Every other Wed evening 7:30 Cadet Girl Scouts
Every 4th Thursday Jaycees 8 pm
Every Thursday 8 pm AA Al Anon
Every Friday 3:15 pm Brownies

CHURCH OF CHRIST OF ST. JOHNS
400 E State
Mike Hargrove, Minister
9:30 am Sunday School
10:30 am Morning Worship
5:30 pm Youth Fellowship
6:30 pm Evening Service
Wed. 7:30 pm Prayer Meeting
Call 224-4293 for more information

ST. JOSEPH CATHOLIC CHURCH
Rev William G. Harker, Pastor
Rev. Raymond Goehring
Associate Pastor
Rectory - 109 Linden St. - Ph. 224-3313
Convent - 110 S. Oakland - Ph. 224-2789
School - 201 E. Cass - Ph. 224-2421.
Mass Schedule
Saturday Evening - 7 pm
Sunday - 7:30, 9, 10:30 and 12.
Holy Days - See bulletin.
Weekdays - 7:30 and 8:30 am and 7:15 pm
Sacrament of Penance - Saturdays, 3:30 to 5 pm; after 7 pm Mass until 9 pm. Weekday evenings - a few minutes before evening Mass.
First Fridays - Sacrament of Penance, Thursday from 4 to 5 pm and after the evening Mass until all are heard. Mass and Prayers of Adoration at 7:15 pm. Holy Communion on Friday at 6 and 7:15 am. Adoration of the Blessed Sacrament, 8:30 pm on Thursday through 7 pm on First Friday.
Devotions - Our Mother of Perpetual Help Novena - after 7:15 pm Mass each Tuesday.
Religious Instruction Classes - Adult Inquiry Class, Tuesday at 8 pm. High School CCD, Wednesday at 6 pm. Public Grade School CCD, Thursday from 4 until 5 pm.
Baptisms - Each Sunday at 1:30 by appointment. Other arrangements by appointment.

SAINT JOHN'S LUTHERAN CHURCH
(Missouri Synod)
Pastor Robert D. Koepfen
10:15 am Divine Worship
8:00 am Matins Service, 3rd Sunday each month
Holy Communion, 1st & 3rd Sundays each month at 10:15 am
Church office hours - 9:00 - 12:00 on Mondays, Wednesdays, Thursdays, Fridays

THE WAYSIDE BAPTIST CHURCH
Rev. Richard Abney, Pastor
About 12 miles north
The Corner of N US-27 and Roosevelt Rds.
Sunday School - 10:00 a.m.
Mornings Worship - 11:00 a.m.
Sunday evening - 6:00 pm
Wednesday evening service
7:00 pm
A church where everyone is welcome

WESLEYAN HOLINESS CHURCH
127 W. William St., Ovid
Rev. Richard D. Purchase
10 am Sunday School and Morning Worship, Sunday Evenings 7:30 pm
7:30 pm Wednesday Prayer Meetings

DEWITT AREA
WAYSIDE CHAPEL
A BIBLE CHURCH
14337 Turner Road, DeWitt
Rev Douglas Beach, Pastor
Phone 489-8251
10 am Sunday School
11 am Worship Service
6 pm Young People
7 pm Evening Service
7:15 pm Wednesday - Bible Study and Prayer
A friendly church with a message for today
Bible Loving - Bible Believing - Bible Preaching
DeWITT COMMUNITY CHURCH
Inter-denominational
Muri J Eastman, Pastor
Jim McGovney,
Sunday School Supt.
Marglyn Kral, Co-Supt
11 am - Church
6 pm - Youth Fellowship
7 pm - Sunday Evening Service
7 pm - Wednesday Bible Study and Prayer Meeting

REDEEMER UNITED METHODIST CHURCH
105 N Bridge St.
H. Forest Crum, Pastor
9:30 am - Worship, (nursery provided), 10:30 - 11:00 am, Coffee Fellowship, 11 am Church School

COMMUNITY OF ST JUDE
Catholic Church
Father Jerome Schmitt, Pastor
409 Wilson, DeWitt
Daily Mass: Mon and Thurs - 7:30 am, Tues, Wed, and Fri 7:00 am
Sunday Mass: 9:00 and 11:15 am
Services at Middle School, DeWitt

EAST DEWITT BIBLE CHURCH
(Non Denominational)
27 Road Lake Road 1/4 mile East of US-27
Glen J. Farnham, Pastor
Sunday
10 am - Sunday School, Classes for all ages
11 am - Morning Worship
5:45 pm - Youth Fellowship, Senior, 14 and up; Jet Cadets, 10-13
7 pm - Evening Service
Wednesday
7:30 pm - Bible Study and prayer. Supervised nursery for babies and small children in all services.
"An open door to an open book"
"A Bible preaching church with a message for you...."

ATTEND THE CHURCH OF YOUR CHOICE

THE AMERICAN RED CROSS

SEVENTH DAY ADVENTISTS
688 North Lansing Street
Elder, E.F. Herzel, Pastor
Services held on Saturday
9:15 am - Church Service
10:30 am - Sabbath School Service

WEST PILGRIM UNITED METHODIST CHURCH
Corner of Parks and Grove Rd
Rev Brian K. Sheen, Minister
9:30 am - Worship Service
10:45 am - Church School

ASSEMBLY OF GOD
SUS-27 & E Baldwin
Joseph F. Eger, Jr, Pastor
10:00 am - Sunday School
11:00 am - Morning Worship
6:30 pm - Youth Service
7:30 pm - Sunday Evening
7:00 pm - Wednesday, second and fourth W.M.
7:30 pm - Wednesday evening service

PRICE UNITED METHODIST CHURCH
Rev. Darold B. Boyd
9:45 am - Church School
11:00 am - Morning Worship
Women's Society meets the 1st, Wednesday of each month, Dinner at 12:30. Meeting at 1:30.
Youth Fellowship meets the first and third Monday of each month at 7:30 pm
Council of Church Ministries and Administrative Board meets the first Sunday of each month following a potluck dinner at noon.
Youth choir meets each Wednesday at 7 pm
Senior choir meets each Wednesday at 7:30 pm

Jehovah's Witnesses
Kingdon Hall
1993 North Lansing St
Tuesday, 7:30 pm - Congregation Book Studies, Text studied: "The Nations Shall Know That I am Jehovah-How?"
Thursday, 7:30 pm - Theocratic Ministry School - Texts Used: "Bible" and "Aid to Bible Understanding" 8:30 pm Service Meeting
Sunday, 9:30 am - Public Lecture - Given by Qualified Representative of the Watchtower, Bible and tract Society, 10:30 am - Watchtower Study - Current issue of the "Watchtower" magazine studies.
PUBLIC INVITED
NO COLLECTION TAKEN

FIRST CHURCH OF GOD
Rev Jeff Webb
312 N US-27
Phone 224-2448
9:45 am Church School, 11:00 am Worship Service, 7:00 pm Evening Worship, 8:00 pm Youth Fellowship 1st and 3rd Sunday of the month.
Wednesday: 7:45 pm Family Bible Study.

CHURCH OF THE NAZARENE
515 North Lansing Street
Rev Wesley Manker
Phone 224-7950
10:00 am - Sunday School
11:00 am - Morning Worship
6:15 pm - Young People's Service
7:00 pm - Evening Worship
Wednesday, 6:30 pm - Caravan, 7:45 pm Bible Study and prayer hour

FREE METHODIST CHURCH
305 Church Street
Phone 224-3248
Robert Bentley, Minister
10:00 am - Sunday School
11:00 am - Morning Worship
6:00 pm - Evening Worship
Prayer service as announced.

SALEM UNITED METHODIST CHURCH
U.S. 27 and County Line Rd
Pastor Paul R. Jones
Phone 224-7709
Parsonage & Office 2620 E. Maple Rapids Rd, Eureka
Sunday
9:00 am - Church School
10:00 am - Church School
7:30 pm WSCS Third Thursday each month

ST. THERESA CATHOLIC CHURCH
Fathers Francis Murray, Joseph Droste and Lawrence Delaney
Rectory: 102 W Handolph, Lansing
Phone 489-9951
Mass Schedule - Saturday: 7 pm
Sunday: 6, 8, 10, 12; DeWitt, 9 am
Holiday: 7, 8, 10 am 5:30, 7:30 pm
Weekday Masses: 8 am, 7:30 pm
Confessions - Saturday: 3:30 to 5 and 7:30 to 9; Eves of Holidays, 8 to 9
Baptism: Sunday at 11 pm Please call in advance

SOUTH HILLY HOLE CHURCH
Willard Farrier, Pastor
Located 1/2 mile east of Francis Road on Chadwick Road
10 am - Sunday School
11 am - Worship Service

HOPE LUTHERAN CHURCH
380 W Herndon Rd, DeWitt
Telephone: 489-3930
David B Franzmoler, Pastor
Telephone: 669-4666
Sunday Worship - 9:30
Tuesday - Directions at Dawn 7:00 am
ST ANNE'S EPISCOPAL CHURCH
Corner US-27 and Webb Road
Rev Glenn V. Cahney, Jr, Vicar
Residence 669 3907 Church 669-9308
First & Third Sundays
Morning Prayer 9 am
Second & Fourth Sundays
Holy Communion 9 am
VALLEY FARMS BAPTIST CHURCH
241 E State Road
Rev LaVern Bretz, Pastor
9:45-10:45 am - Church School. There is a class for everyone from the youngest to the oldest. The Bible is our textbook.
11 am - 12 Noon - Morning Worship, Junior Church for children through 6th grade.
8:30 pm - BYF for both Juniors and Seniors
7:00 pm - Evangelistic Service
6:00 pm - Morning Choir Practices
Wednesday, 7:00 pm - Mid-week Prayer Service; 8:00 pm - Morning Choir Practice
Saturday 10:00 am - Jr Choir practice
1st Thursday 7:30 pm - Woman's Mission Society
2nd Saturday 2:00 pm - Ann Judson Guild for Jr. Hi girls
3rd Tuesday 6:30 pm - Men's Fellowship

WESLEYAN HOLINESS CHURCH
127 W William St., Ovid
Rev Richard D. Purchase
10 am Sunday School and Morning Worship, Sunday Evenings 7:30 pm
7:30 pm Wednesday Prayer Meetings

WESLEYAN HOLINESS CHURCH
127 W William St., Ovid
Rev Richard D. Purchase
10 am Sunday School and Morning Worship, Sunday Evenings 7:30 pm
7:30 pm Wednesday Prayer Meetings

WESLEYAN HOLINESS CHURCH
127 W William St., Ovid
Rev Richard D. Purchase
10 am Sunday School and Morning Worship, Sunday Evenings 7:30 pm
7:30 pm Wednesday Prayer Meetings

WESLEYAN HOLINESS CHURCH
127 W William St., Ovid
Rev Richard D. Purchase
10 am Sunday School and Morning Worship, Sunday Evenings 7:30 pm
7:30 pm Wednesday Prayer Meetings

WESLEYAN HOLINESS CHURCH
127 W William St., Ovid
Rev Richard D. Purchase
10 am Sunday School and Morning Worship, Sunday Evenings 7:30 pm
7:30 pm Wednesday Prayer Meetings

WESLEYAN HOLINESS CHURCH
127 W William St., Ovid
Rev Richard D. Purchase
10 am Sunday School and Morning Worship, Sunday Evenings 7:30 pm
7:30 pm Wednesday Prayer Meetings

WESLEYAN HOLINESS CHURCH
127 W William St., Ovid
Rev Richard D. Purchase
10 am Sunday School and Morning Worship, Sunday Evenings 7:30 pm
7:30 pm Wednesday Prayer Meetings

WESLEYAN HOLINESS CHURCH
127 W William St., Ovid
Rev Richard D. Purchase
10 am Sunday School and Morning Worship, Sunday Evenings 7:30 pm
7:30 pm Wednesday Prayer Meetings

ST. THERESA CATHOLIC CHURCH
Fathers Francis Murray, Joseph Droste and Lawrence Delaney
Rectory: 102 W Handolph, Lansing
Phone 489-9951
Mass Schedule - Saturday: 7 pm
Sunday: 6, 8, 10, 12; DeWitt, 9 am
Holiday: 7, 8, 10 am 5:30, 7:30 pm
Weekday Masses: 8 am, 7:30 pm
Confessions - Saturday: 3:30 to 5 and 7:30 to 9; Eves of Holidays, 8 to 9
Baptism: Sunday at 11 pm Please call in advance

SOUTH HILLY HOLE CHURCH
Willard Farrier, Pastor
Located 1/2 mile east of Francis Road on Chadwick Road
10 am - Sunday School
11 am - Worship Service

HOPE LUTHERAN CHURCH
380 W Herndon Rd, DeWitt
Telephone: 489-3930
David B Franzmoler, Pastor
Telephone: 669-4666
Sunday Worship - 9:30
Tuesday - Directions at Dawn 7:00 am
ST ANNE'S EPISCOPAL CHURCH
Corner US-27 and Webb Road
Rev Glenn V. Cahney, Jr, Vicar
Residence 669 3907 Church 669-9308
First & Third Sundays
Morning Prayer 9 am
Second & Fourth Sundays
Holy Communion 9 am
VALLEY FARMS BAPTIST CHURCH
241 E State Road
Rev LaVern Bretz, Pastor
9:45-10:45 am - Church School. There is a class for everyone from the youngest to the oldest. The Bible is our textbook.
11 am - 12 Noon - Morning Worship, Junior Church for children through 6th grade.
8:30 pm - BYF for both Juniors and Seniors
7:00 pm - Evangelistic Service
6:00 pm - Morning Choir Practices
Wednesday, 7:00 pm - Mid-week Prayer Service; 8:00 pm - Morning Choir Practice
Saturday 10:00 am - Jr Choir practice
1st Thursday 7:30 pm - Woman's Mission Society
2nd Saturday 2:00 pm - Ann Judson Guild for Jr. Hi girls
3rd Tuesday 6:30 pm - Men's Fellowship

HOPE LUTHERAN CHURCH
380 W Herndon Rd, DeWitt
Telephone: 489-3930
David B Franzmoler, Pastor
Telephone: 669-4666
Sunday Worship - 9:30
Tuesday - Directions at Dawn 7:00 am
ST ANNE'S EPISCOPAL CHURCH
Corner US-27 and Webb Road
Rev Glenn V. Cahney, Jr, Vicar
Residence 669 3907 Church 669-9308
First & Third Sundays
Morning Prayer 9 am
Second & Fourth Sundays
Holy Communion 9 am
VALLEY FARMS BAPTIST CHURCH
241 E State Road
Rev LaVern Bretz, Pastor
9:45-10:45 am - Church School. There is a class for everyone from the youngest to the oldest. The Bible is our textbook.
11 am - 12 Noon - Morning Worship, Junior Church for children through 6th grade.
8:30 pm - BYF for both Juniors and Seniors
7:00 pm - Evangelistic Service
6:00 pm - Morning Choir Practices
Wednesday, 7:00 pm - Mid-week Prayer Service; 8:00 pm - Morning Choir Practice
Saturday 10:00 am - Jr Choir practice
1st Thursday 7:30 pm - Woman's Mission Society
2nd Saturday 2:00 pm - Ann Judson Guild for Jr. Hi girls
3rd Tuesday 6:30 pm - Men's Fellowship

HOPE LUTHERAN CHURCH
380 W Herndon Rd, DeWitt
Telephone: 489-3930
David B Franzmoler, Pastor
Telephone: 669-4666
Sunday Worship - 9:30
Tuesday - Directions at Dawn 7:00 am
ST ANNE'S EPISCOPAL CHURCH
Corner US-27 and Webb Road
Rev Glenn V. Cahney, Jr, Vicar
Residence 669 3907 Church 669-9308
First & Third Sundays
Morning Prayer 9 am
Second & Fourth Sundays
Holy Communion 9 am
VALLEY FARMS BAPTIST CHURCH
241 E State Road
Rev LaVern Bretz, Pastor
9:45-10:45 am - Church School. There is a class for everyone from the youngest to the oldest. The Bible is our textbook.
11 am - 12 Noon - Morning Worship, Junior Church for children through 6th grade.
8:30 pm - BYF for both Juniors and Seniors
7:00 pm - Evangelistic Service
6:00 pm - Morning Choir Practices
Wednesday, 7:00 pm - Mid-week Prayer Service; 8:00 pm - Morning Choir Practice
Saturday 10:00 am - Jr Choir practice
1st Thursday 7:30 pm - Woman's Mission Society
2nd Saturday 2:00 pm - Ann Judson Guild for Jr. Hi girls
3rd Tuesday 6:30 pm - Men's Fellowship

HOPE LUTHERAN CHURCH
380 W Herndon Rd, DeWitt
Telephone: 489-3930
David B Franzmoler, Pastor
Telephone: 669-4666
Sunday Worship - 9:30
Tuesday - Directions at Dawn 7:00 am
ST ANNE'S EPISCOPAL CHURCH
Corner US-27 and Webb Road
Rev Glenn V. Cahney, Jr, Vicar
Residence 669 3907 Church 669-9308
First & Third Sundays
Morning Prayer 9 am
Second & Fourth Sundays
Holy Communion 9 am
VALLEY FARMS BAPTIST CHURCH
241 E State Road
Rev LaVern Bretz, Pastor
9:45-10:45 am - Church School. There is a class for everyone from the youngest to the oldest. The Bible is our textbook.
11 am - 12 Noon - Morning Worship, Junior Church for children through 6th grade.
8:30 pm - BYF for both Juniors and Seniors
7:00 pm - Evangelistic Service
6:00 pm - Morning Choir Practices
Wednesday, 7:00 pm - Mid-week Prayer Service; 8:00 pm - Morning Choir Practice
Saturday 10:00 am - Jr Choir practice
1st Thursday 7:30 pm - Woman's Mission Society
2nd Saturday 2:00 pm - Ann Judson Guild for Jr. Hi girls
3rd Tuesday 6:30 pm - Men's Fellowship

HOPE LUTHERAN CHURCH
380 W Herndon Rd, DeWitt
Telephone: 489-3930
David B Franzmoler, Pastor
Telephone: 669-4666
Sunday Worship - 9:30
Tuesday - Directions at Dawn 7:00 am
ST ANNE'S EPISCOPAL CHURCH
Corner US-27 and Webb Road
Rev Glenn V. Cahney, Jr, Vicar
Residence 669 3907 Church 669-9308
First & Third Sundays
Morning Prayer 9 am
Second & Fourth Sundays
Holy Communion 9 am
VALLEY FARMS BAPTIST CHURCH
241 E State Road
Rev LaVern Bretz, Pastor
9:45-10:45 am - Church School. There is a class for everyone from the youngest to the oldest. The Bible is our textbook.
11 am - 12 Noon - Morning Worship, Junior Church for children through 6th grade.
8:30 pm - BYF for both Juniors and Seniors
7:00 pm - Evangelistic Service
6:00 pm - Morning Choir Practices
Wednesday, 7:00 pm - Mid-week Prayer Service; 8:00 pm - Morning Choir Practice
Saturday 10:00 am - Jr Choir practice
1st Thursday 7:30 pm - Woman's Mission Society
2nd Saturday 2:00 pm - Ann Judson Guild for Jr. Hi girls
3rd Tuesday 6:30 pm - Men's Fellowship

HOPE LUTHERAN CHURCH
380 W Herndon Rd, DeWitt
Telephone: 489-3930
David B Franzmoler, Pastor
Telephone: 669-4666
Sunday Worship - 9:30
Tuesday - Directions at Dawn 7:00 am
ST ANNE'S EPISCOPAL CHURCH
Corner US-27 and Webb Road
Rev Glenn V. Cahney, Jr, Vicar
Residence 669 3907 Church 669-9308
First & Third Sundays
Morning Prayer 9 am
Second & Fourth Sundays
Holy Communion 9 am
VALLEY FARMS BAPTIST CHURCH
241 E State Road
Rev LaVern Bretz, Pastor
9:45-10:45 am - Church School. There is a class for everyone from the youngest to the oldest. The Bible is our textbook.
11 am - 12 Noon - Morning Worship, Junior Church for children through 6th grade.
8:30 pm - BYF for both Juniors and Seniors
7:00 pm - Evangelistic Service
6:00 pm - Morning Choir Practices
Wednesday, 7:00 pm - Mid-week Prayer Service; 8:00 pm - Morning Choir Practice
Saturday 10:00 am - Jr Choir practice
1st Thursday 7:30 pm - Woman's Mission Society
2nd Saturday 2:00 pm - Ann Judson Guild for Jr. Hi girls
3rd Tuesday 6:30 pm - Men's Fellowship

HOPE LUTHERAN CHURCH
380 W Herndon Rd, DeWitt
Telephone: 489-3930
David B Franzmoler, Pastor
Telephone: 669-4666
Sunday Worship - 9:30
Tuesday - Directions at Dawn 7:00 am
ST ANNE'S EPISCOPAL CHURCH
Corner US-27 and Webb Road
Rev Glenn V. Cahney, Jr, Vicar
Residence 669 3907 Church 669-9308
First & Third Sundays
Morning Prayer 9 am
Second & Fourth Sundays
Holy Communion 9 am
VALLEY FARMS BAPTIST CHURCH
241 E State Road
Rev LaVern Bretz, Pastor
9:45-10:45 am - Church School. There is a class for everyone from the youngest to the oldest. The Bible is our textbook.
11 am - 12 Noon - Morning Worship, Junior Church for children through 6th grade.
8:30 pm - BYF for both Juniors and Seniors
7:00 pm - Evangelistic Service
6:00 pm - Morning Choir Practices
Wednesday, 7:00 pm - Mid-week Prayer Service; 8:00 pm - Morning Choir Practice
Saturday 10:00 am - Jr Choir practice
1st Thursday 7:30 pm - Woman's Mission Society
2nd Saturday 2:00 pm - Ann Judson Guild for Jr. Hi girls
3rd Tuesday 6:30 pm - Men's Fellowship

HOPE LUTHERAN CHURCH
380 W Herndon Rd, DeWitt
Telephone: 489-3930
David B Franzmoler, Pastor
Telephone: 669-4666
Sunday Worship - 9:30
Tuesday - Directions at Dawn 7:00 am
ST ANNE'S EPISCOPAL CHURCH
Corner US-27 and Webb Road
Rev Glenn V. Cahney, Jr, Vicar
Residence 669 3907 Church 669-9308
First & Third Sundays
Morning Prayer 9 am
Second & Fourth Sundays
Holy Communion 9 am
VALLEY FARMS BAPTIST CHURCH
241 E State Road
Rev LaVern Bretz, Pastor
9:45-10:45 am - Church School. There is a class for everyone from the youngest to the oldest. The Bible is our textbook.
11 am - 12 Noon - Morning Worship, Junior Church for children through 6th grade.
8:30 pm - BYF for both Juniors and Seniors
7:00 pm - Evangelistic Service
6:00 pm - Morning Choir Practices
Wednesday, 7:00 pm - Mid-week Prayer Service; 8:00 pm - Morning Choir Practice
Saturday 10:00 am - Jr Choir practice
1st Thursday 7:30 pm - Woman's Mission Society
2nd Saturday 2:00 pm - Ann Judson Guild for Jr. Hi girls
3rd Tuesday 6:30 pm - Men's Fellowship

HOPE LUTHERAN CHURCH
380 W Herndon Rd, DeWitt
Telephone: 489-3930
David B Franzmoler, Pastor
Telephone: 669-4666
Sunday Worship - 9:30
Tuesday - Directions at Dawn 7:00 am
ST ANNE'S EPISCOPAL CHURCH
Corner US-27 and Webb Road
Rev Glenn V. Cahney, Jr, Vicar
Residence 669 3907 Church 669-9308
First & Third Sundays
Morning Prayer 9 am
Second & Fourth Sundays
Holy Communion 9 am
VALLEY FARMS BAPTIST CHURCH
241 E State Road
Rev LaVern Bretz, Pastor
9:45-10:45 am - Church School. There is a class for everyone from the youngest to the oldest. The Bible is our textbook.
11 am - 12 Noon - Morning Worship, Junior Church for children through 6th grade.
8:30 pm - BYF for both Juniors and Seniors
7:00 pm - Evangelistic Service
6:00 pm - Morning Choir Practices
Wednesday, 7:00 pm - Mid-week Prayer Service; 8:00 pm - Morning Choir Practice
Saturday 10:00 am - Jr Choir practice
1st Thursday 7:30 pm - Woman's Mission Society
2nd Saturday 2:00 pm - Ann Judson Guild for Jr. Hi girls
3rd Tuesday 6:30 pm - Men's Fellowship

HOPE LUTHERAN CHURCH
380 W Herndon Rd, DeWitt
Telephone: 489-3930
David B Franzmoler, Pastor
Telephone: 669-4666
Sunday Worship - 9:30
Tuesday - Directions at Dawn 7:00 am
ST ANNE'S EPISCOPAL CHURCH
Corner US-27 and Webb Road
Rev Glenn V. Cahney, Jr, Vicar
Residence 669 3907 Church 669-9308
First & Third Sundays
Morning Prayer 9 am
Second & Fourth Sundays
Holy Communion 9 am
VALLEY FARMS BAPTIST CHURCH
241 E State Road
Rev LaVern Bretz, Pastor
9:45-10:45 am - Church School. There is a class for everyone from the youngest to the oldest. The Bible is our textbook.
11 am - 12 Noon - Morning Worship, Junior Church for children through 6th grade.
8:30 pm - BYF for both Juniors and Seniors
7:00 pm - Evangelistic Service
6:00 pm - Morning Choir Practices
Wednesday, 7:00 pm - Mid-week Prayer Service; 8:00 pm - Morning Choir Practice
Saturday 10:00 am - Jr Choir practice
1st Thursday 7:30 pm - Woman's Mission Society
2nd Saturday 2:00 pm - Ann Judson Guild for Jr. Hi girls
3rd Tuesday 6:30 pm - Men's Fellowship

HOPE LUTHERAN CHURCH
380 W Herndon Rd, DeWitt
Telephone: 489-3930
David B Franzmoler, Pastor
Telephone: 669-4666
Sunday Worship - 9:30
Tuesday - Directions at Dawn 7:00 am
ST ANNE'S EPISCOPAL CHURCH
Corner US-27 and Webb Road
Rev Glenn V. Cahney, Jr, Vicar
Residence 669 3907 Church 669-9308
First & Third Sundays
Morning Prayer 9 am
Second & Fourth Sundays
Holy Communion 9 am
VALLEY FARMS BAPTIST CHURCH
241 E State Road
Rev LaVern Bretz, Pastor
9:45-10:45 am - Church School. There is a class for everyone from the youngest to the oldest. The Bible is our textbook.
11 am - 12 Noon - Morning Worship, Junior Church for children through 6th grade.
8:30 pm - BYF for both Juniors and Seniors
7:00 pm - Evangelistic Service
6:00 pm - Morning Choir Practices
Wednesday, 7:00 pm - Mid-week Prayer Service; 8:00 pm - Morning Choir Practice
Saturday 10:00 am - Jr Choir practice
1st Thursday 7:30 pm - Woman's Mission Society
2nd Saturday 2:00 pm - Ann Judson Guild for Jr. Hi girls
3rd Tuesday 6:30 pm - Men's Fellowship

HOPE LUTHERAN CHURCH
380 W Herndon Rd, DeWitt
Telephone: 489-3930
David B Franzmoler, Pastor
Telephone: 669-4666
Sunday Worship - 9:30
Tuesday - Directions at Dawn 7:00 am
ST ANNE'S EPISCOPAL CHURCH
Corner US-27 and Webb Road
Rev Glenn V. Cahney, Jr, Vicar
Residence 669 3907 Church 669-9308
First & Third Sundays
Morning Prayer 9 am
Second & Fourth Sundays
Holy Communion 9 am
VALLEY FARMS BAPTIST CHURCH
241 E State Road
Rev LaVern Bretz, Pastor
9:45-10:45 am - Church School. There is a class for everyone from the youngest to the oldest. The Bible is our textbook.
11 am - 12 Noon - Morning Worship, Junior Church for children through 6th grade.
8:30 pm - BYF for both Juniors and Seniors
7:00 pm - Evangelistic Service
6:00 pm - Morning Choir Practices
Wednesday, 7:00 pm - Mid-week Prayer Service; 8:00 pm - Morning Choir Practice
Saturday 10:00 am - Jr Choir practice
1st Thursday 7:30 pm - Woman's Mission Society
2nd Saturday 2:00 pm - Ann Judson Guild for Jr. Hi girls
3rd Tuesday 6:30 pm - Men's Fellowship

HOPE LUTHERAN CHURCH
380 W Herndon Rd, DeWitt
Telephone: 489-3930
David B Franzmoler, Pastor
Telephone: 669-4666
Sunday Worship - 9:30
Tuesday - Directions at Dawn 7:00 am
ST ANNE'S EPISCOPAL CHURCH
Corner US-27 and Webb Road
Rev Glenn V. Cahney, Jr, Vicar
Residence 669 3907 Church 669-9308
First & Third Sundays
Morning Prayer 9 am
Second & Fourth Sundays
Holy Communion 9 am
VALLEY FARMS BAPTIST CHURCH
241 E State Road
Rev LaVern Bretz, Pastor
9:45-10:45 am - Church School. There is a class for everyone from the youngest to the oldest. The Bible is our textbook.
11 am - 12 Noon - Morning Worship, Junior Church for children through 6th grade.
8:30 pm - BYF for both Juniors and Seniors
7:00 pm - Evangelistic Service
6:00 pm - Morning Choir Practices
Wednesday, 7:00 pm - Mid-week Prayer Service; 8:00 pm - Morning Choir Practice
Saturday 10:00 am - Jr Choir practice
1st Thursday 7:30 pm - Woman's Mission Society
2nd Saturday 2:00 pm - Ann Judson Guild for Jr. Hi girls
3rd Tuesday 6:30 pm - Men's Fellowship

HOPE LUTHERAN CHURCH
380 W Herndon Rd, DeWitt
Telephone: 489-3930
David B Franzmoler, Pastor
Telephone: 669-4666
Sunday Worship - 9:30
Tuesday - Directions at Dawn 7:00 am
ST ANNE'S EPISCOPAL CHURCH
Corner US-27 and Webb Road
Rev Glenn V. Cahney, Jr, Vicar
Residence 669 3907 Church 669-9308
First & Third Sundays
Morning Prayer 9 am
Second & Fourth Sundays
Holy Communion 9 am
VALLEY FARMS BAPTIST CHURCH
241 E State Road
Rev LaVern Bretz, Pastor
9:45-10:45 am - Church School. There is a class for everyone from the youngest to the oldest. The Bible is our textbook.
11 am - 12 Noon - Morning Worship, Junior Church for children through 6th grade.
8:30 pm - BYF for both Juniors and Seniors
7:00 pm - Evangelistic Service
6:00 pm - Morning Choir Practices
Wednesday, 7:00 pm - Mid-week Prayer Service; 8:00 pm - Morning Choir Practice
Saturday 10:00 am - Jr Choir practice
1st Thursday 7:30 pm - Woman's Mission Society
2nd Saturday 2:00 pm - Ann Judson Guild for Jr. Hi girls
3rd Tuesday 6:30 pm - Men's Fellowship

HOPE LUTHERAN CHURCH
380 W Herndon Rd, DeWitt
Telephone: 489-3930
David B Franzmoler, Pastor
Telephone: 669-4666
Sunday Worship - 9:30
Tuesday - Directions at Dawn 7:00 am
ST ANNE'S EPISCOPAL CHURCH
Corner US-27 and Webb Road
Rev Glenn V. Cahney, Jr, Vicar
Residence 669 3907 Church 669-9308
First & Third Sundays
Morning Prayer 9 am
Second & Fourth Sundays
Holy Communion 9 am
VALLEY FARMS BAPTIST CHURCH
241 E State Road
Rev LaVern Bretz, Pastor
9:45-10:45 am - Church School. There is a class for everyone from the youngest to the oldest. The Bible is our textbook.
11 am - 12 Noon - Morning Worship, Junior Church for children through 6th grade.
8:30 pm - BYF for both Juniors and Seniors
7:00 pm - Evangelistic Service
6:00 pm - Morning Choir Practices
Wednesday, 7:00 pm - Mid-week Prayer Service; 8:00 pm - Morning Choir Practice
Saturday 10:00 am - Jr Choir practice
1st Thursday 7:30 pm - Woman's Mission Society
2nd Saturday 2:00 pm - Ann Judson Guild for Jr. Hi girls
3rd Tuesday 6:30 pm - Men's Fellowship

HOPE LUTHERAN CHURCH
380 W Herndon Rd, DeWitt
Telephone: 489-3930
David B Franzmoler, Pastor
Telephone: 669-4666
Sunday Worship - 9:30
Tuesday - Directions at Dawn 7:00 am
ST ANNE'S EPISCOPAL CHURCH
Corner US-27 and Webb Road
Rev Glenn V. Cahney, Jr, Vicar
Residence 669 3907 Church 669-9308
First

Irish Hills: attractive spot for camping and sightseeing

The picturesque Irish Hills, one of the beauty spots of Michigan, and a variety of tourist and historical attractions, form a backdrop for campers at W.J. Hayes State Park, according to Automobile Club of Michigan.

The 654-acre park, nine miles west of Clinton on US-12 and M-124, is spread over rolling scenic hills and includes all of Round Lake and a half mile of sandy beach on Wampers Lake. The park has 210 campsites, 156 with electricity.

Last year's attendance was 483,250, which places Hayes sixth among 32 parks across southern and central Michigan.

Boats are available at a concession on Wampers Lake. A modern outdoor center for small groups is

located in a wooded section of the park's interior. Other features include an extensive picnic area, bathhouse, library, boat livery and store. There also is a sanitary disposal station. The area's attractions contribute greatly to the park's popularity.

Twin observation towers, on US-12 east of Cambridge Junction, afford a panoramic view of the hills. There is an admission charge to the towers.

Cambridge State Historic Park is at the intersection of US-12 and M-50. In the park is historic Walker Tavern, an oldtime stagecoach tavern built in 1832 and associated with several prominent persons in American history. The tavern is undergoing restoration, and at present is not open to the public.

St Joseph's Shrine, a stone church on US-12 east of Cambridge Junction, is an enlargement of a stone chapel built by Irish settlers in 1854. The Shrine has drawn uncounted multitudes of worshippers to its Outdoor Stations of the Cross along a small lake.

The Hidden Lake Gardens, at Tipton, is comprised of 620 acres of rolling Irish Hills. The gardens were a gift to Michigan State University in 1945.

Strung out in other areas are a score of other attractions, ranging from a "Prehistoric Forest" to gravity-defying "Mystery Hill," where water runs up and people can't fall down.

Not far away is the Michigan International Speedway and recently opened Greenwood Acres; a

sort of country club for camping families.

Most extensive of all the attractions is "Stagecoach Stop", an 1890-vintage Wild West town now in its ninth season. It's also on US-12, three miles east of the M-50 and US-12 intersection.

Other attractions in the nearby area include the Irish Hills Playhouse, Slayton Arboretum at Hillsdale, Bauer Manor, a roadhouse dating to 1834, located seven miles west of Clinton on US-40 and still a restaurant; Springville Inn, six miles west of Tipton on M-50, another old roadhouse now an antiqueshop; and Monroe Historical Museum, on the site of the first settler's home in the Monroe area.



By Jose J. Llinas, MD
Director of Community
Mental Health Clinic,
Eaton and Ingham

Riley and Olive

On Sunday, Aug 12, over 75 members of the Charles and Julia Ernst family gathered at St Peter Church Hall for a picnic dinner and a good visit with each other. They hailed from Ionia, Battle Creek, St Johns, Fowler, DeWitt, Lansing, Holt, Mt Pleasant, Reed City, Grand Ledge, and Ringwood, Ill, and Columbia, Mo.

Among the guests were Mr and Mrs John Ernst Jr and Jeff of Ill former residents of Lansing and St Johns area; also Karl Ernst who was home on leave and is stationed overseas with the U.S. Forces.

Mr and Mrs Ray Moore attended the wedding of Lenore Wood and Mike Cornell on Sunday afternoon at DeWitt. Several other neighbors attended also.

The Olive's 4-H Projects Club members were all winners at the County 4-H Fair as were all the other club members. Each member received a ribbon or more, either blue, red or white. There was lots of activity down there; if anyone missed attending, they really missed a joyful event.

Mr and Mrs Ted Piotrowicz and children were Saturday visitors of their parents, Mr and Mrs Lloyd Brocker.

Mr and Mrs Fred Sehlke of Fowler were Friday evening visitors of Mr and Mrs Ray Moore.

Our state is doing something effective about the physician shortage. All three of our medical schools (Michigan, M.S.U. and Wayne State) are graduating more doctors than ever before.

This summer, Michigan graduated 207 new practitioners; M.S.U. 32 and W.S.U. 121. In addition, the new College of Osteopathic Medicine at M.S.U., the first osteopathic school to be associated with a large state university, sent out its first group of physician graduates, all 44 of them.

These good news and more are reported by Herbert A. Auer, from the state medical society, in a recent issue of Michigan Hospitals.

A NATIONAL TREND
What's more, in this case one can say that as Michigan goes, so goes the nation. Auer points to a number of facts which are true both for our own state and for the United States at large.

There are more first year students enrolled in the 108 approved medical schools in the nation than ever before. A record number of new licenses to practice medicine were issued in 1971; and in that year alone nine new medical schools opened their doors.

29,172 young people applied for the 12,361 available places, so we still have a ways to go.

In addition 10,947 foreign physicians entered the United States, half of that number as permanent immigrants.

HELP ON THE WAY

"What good are these statistics to me", you may reasonably ask, "when I can't find a doctor I could see in less than a month?"

The answer is that it takes time for these efforts to reach an impact on communities which are desperately looking for physicians. In the first place,

most graduates cannot or will not go into practice right after finishing medical school. Most of them require extra training to perform adequately.

But even here we are making progress. An outstanding example in our own area of a program that is providing us with medical manpower, is the Family Practice Residency at Sparrow Hospital, under Dr H.E. Crow. Established in 1970, the three year program has two competent physicians coming out as excellent family practitioners this year. One will settle in Grand Ledge; the other one in Jackson. Next year, there will be six residents finishing their training. One other interesting point about this very successful program is that Mason General Hospital, south of Lansing and the city's Sparrow Hospital are joining forces to provide this kind of training.

There are only 9,000 physicians in Michigan, and with our 8 million-plus population figure, we need many more. But little by little, thanks to the efforts of many concerned people, we are getting there.

Wholesale price index decreases

WHOLESALE PRICE INDEX: JULY 1973
WASHINGTON -- The Wholesale Price Index for All Commodities decreased 1.3 percent from June to July, the U.S. Department of Labor's Bureau of Labor Statistics has announced.

Prices of farm products and processed foods and feeds declined 4.1 percent, due primarily to lower quotations for animal feeds, soybeans, and grains.

Industrial commodity prices were, on the average, unchanged.

Consumer finished goods, a selection of food and nonfood commodities closely comparable with those in the commodity component of the Consumer Price Index, rose 0.2 percent.

Of the 15 major commodity groups measured by the Wholesale Price Index, 8 advanced from June to July, 4 declined, and 3 showed no change.

In July, the All Commodities WPI was 134.9 (1967-100), 12.7 percent above a year earlier; the industrial commodities index was 7.5 percent higher than in July 1972.

On a seasonally adjusted basis, the All Commodities Wholesale Price Index declined 1.4 percent in July.

Farm products and processed foods and feeds decreased 4.6 percent.

Industrial commodities increased 0.1 percent.

Consumer finished goods were down 0.2 percent.

In the 6-month period ended in July, the All Commodities Wholesale Price Index rose at a seasonally adjusted annual rate of 16.6 percent. Prices in the last 3 months of the period rose less than in the first 3 months because of the July decline in prices of both farm products and processed foods and feeds, and the deceleration for industrial commodities. The July decline of 1.4 percent in the all commodities index compares with an average monthly rise of 1.7 percent during the 6 months from December 1972 to June 1973. The 4.6 percent decrease over the month in the index for farm products and processed foods and feeds contrasts with an average monthly advance of 3.3 percent in the previous 6 months.

The monthly advance of 0.1 percent for industrial commodities was far below the average monthly increase of 1.0 percent in the period from December to June. For consumer finished goods, the comparable figures are a decline of 0.2 percent for July versus an average monthly increase of 1.4 percent for the December-to-June period.

Among consumer finished goods, foods fell 0.8 percent in July after seasonal adjustment, principally

because of declines for eggs and fresh vegetables and smaller-than-seasonal increases for beef and veal and processed poultry. Consumer nonfood finished goods decreased 0.2 percent over the month.

The substantial July declines in the agriculture-related indexes (farm products and processed foods and feeds) were due in considerable measure to reversals in prices of commodities which had caused overall advances earlier. A decrease of 4.9

percent for farm products principally reflected lower prices for soybeans and grains. Manufactured animal feeds were responsible for almost all of the 3.5 percent decline for processed foods and feeds.

(EDITOR'S NOTE: The July decline is based almost entirely on prices prevailing on July 10 after the price freeze was announced by the President on June 13. Some commodities included in the index were also subject to export restrictions implemented after that date.

Powell commends tax reduction in St Johns

State Representative Stanley M. Powell (R-Ionia) has issued the following statement:

"I was very pleased to read that the St Johns taxpayers will be getting a one-mill reduction in their school taxes next year. It was pointed out in the article that the reduction was possible because of increased valuations.

"I would also like to suggest that this reduction and perhaps additional reductions in the future are possible because of the state school aid measure passed this year by the Legislature.

"The St Johns School District will be receiving \$93.28 more per pupil under the bill (Senate Bill 110) than they did in the current school year. I was proud to have been a part of bringing about passage of a school aid bill that not only brings about more equity in the financing of our schools with increased education dollars, but a plan that will allow us to keep faith with the taxpayers by maintaining our state surplus which will be returned to them through the recently-enacted tax relief proposals.

"I commend the St Johns School Board for making this reduction in the tax bill, and I commend my colleagues in the Legislature for providing a school aid bill that was reasonable and equitable.

"With this kind of attitude prevailing at the local and state level, I feel that the overburdened property taxpayer will continue to receive the kind of break he has been pleading for while at the same time providing equal, quality education for all of Michigan's school children."

NOTICE ST. JOHNS OIL CUSTOMERS

We are sorry to announce that fuel oil will be on strict supply this winter. Suggest fill-ups now. TERMS: Cash or 10 days cash. No budget plans. No extensions. Suggest you arrange your budget as such. Persons with delinquent accounts will have to settle back balances before future deliveries. This action necessary and cannot be a voided due to increased pressure of Major Suppliers to put us Independent Companies out of business. Seems as they state it, "We have a new ball game, play by our rules or face shut-off".

Your cooperation will be greatly appreciated and will allow us to fight back against monopoly pressure and to fight for Free Enterprise and Competitive Prices. If the Small Business is allowed to fail, you the Consumer will pay the price.

Please call today and sign up for your automatic fill service for the future heating season.

We Thank You,

Gary and Linda Biddinger-Owners
St. Johns Oil Co.

Pd. Adv.

Wickes

Wickes is the Place

for VALUES in KITCHENS

Prices Good Thru **Sept. 5**

8ft. ambassador KITCHEN

The apple of your eye. Rush into Wickes for a look at this great buy in kitchen cabinets. Elegant, mellow wood finish accented by dark borders. Quality constructed for lasting durability.

SAVE \$52.00 on this 8 ft. kitchen.

\$199.00

Reg. \$251.00

INCLUDES:
2-30" Wall Cabinets • 1-36" Sink Front
2-30" Base Cabinets • 1-36" Valance
1-8" Counter Top

10% Savings on all other Kitchen Cabinets.

a Complete Kitchen Department

Wickes complete kitchen department. At Wickes you'll find a complete choice of quality crafted kitchen cabinets in a selection of styles and sizes to fit your needs. You can customize your kitchen the way you want to. Also, see Wickes for low prices on name brand kitchen appliances.

Time Payment Plan

When you need things now, you can pay later at Wickes. See our Credit Chief, he has a TP to suit every building and redecorating need.

Installed Service

Buy it now—enjoy it now with no work. Wickes installs most of the products and materials they sell. Put Wickes to work for you

WHIRLPOOL UNDERCOUNTER DISHWASHER

Wash the blues away Full-size jet spray arm. Self-cleaning filter, no pre-rinsing required.

\$154.00 Each
Reg. \$164.00

SXU-300

WHIRLPOOL COOKTOP

Cook up a real deal during Wickes Grand Opening. Electric cook top, infinite heat controls. Spillguard top.

\$72.00 Each
Reg. \$82.00

RYE 8400

WHIRLPOOL ELECTRIC RANGE

Infinite heat controls. Spillguard top with signal lights. Radiant heat broiler, dual oven controls. Removable oven door for easy cleaning.

\$169.00 Each
Reg. \$189.00

RYE 7000

WHIRLPOOL ELECTRIC RANGE

Free standing range. Infinite heat controls. Spillguard top. Dual oven controls. Easy to clean, removable oven door.

\$159.00 Each
Reg. \$179.00

RYE 3500

STAINLESS STEEL SINK

32" x 21" double bowl; self-rimming, modern styling.

\$17.76 Each
Reg. \$25.95

Single Handle Faucet Reg. \$19.45 Each \$16.88

CHAIN PENDANT LIGHT

18" diameter. White hobnail glass globe. Choice of Antique Brass, Avocado, Harvest Gold.

\$18.88 Each
Reg. \$23.90

3680 West Monroe Road
ALMA, MICHIGAN
Telephone: 463-4936

STORE HOURS: MON.-THURS.-8 a.m. - 6:30 p.m.
FRI.-8 a.m. - 9 p.m.
SAT.-8 a.m. - 4 p.m.

THESE GRAND OPENING VALUES ALSO AVAILABLE AT THE WICKES CENTER IN CLARE

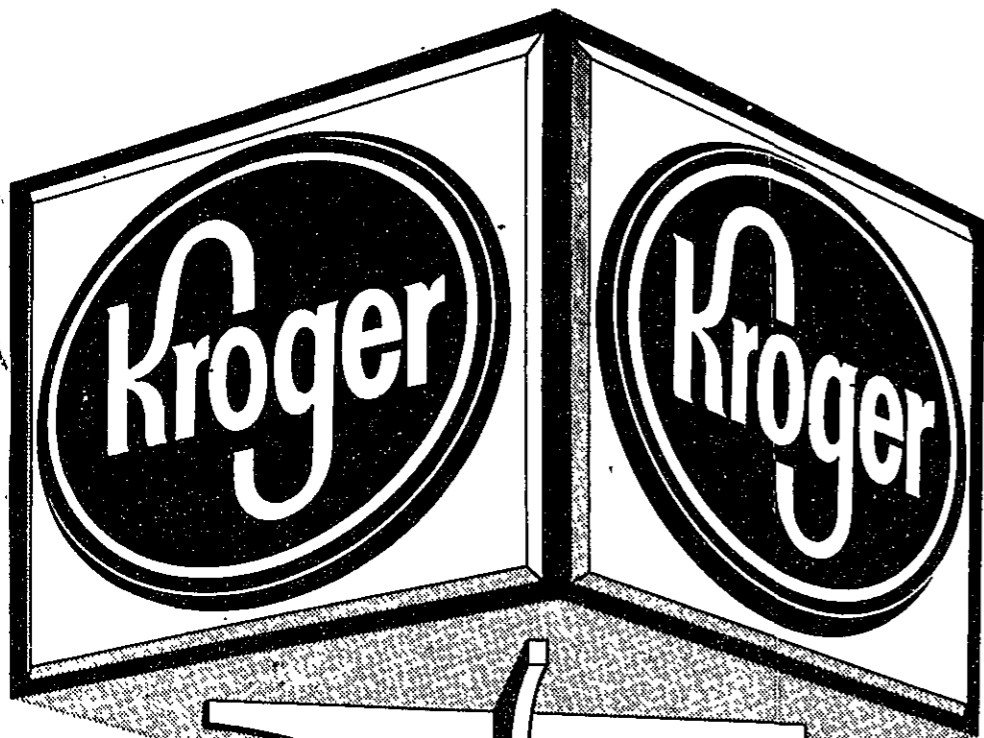

4th
Big Week!

Grand Opening

Lansing's Largest And Finest Kroger

SUPERSTORE

CITY-WIDE CELEBRATION CONTINUES

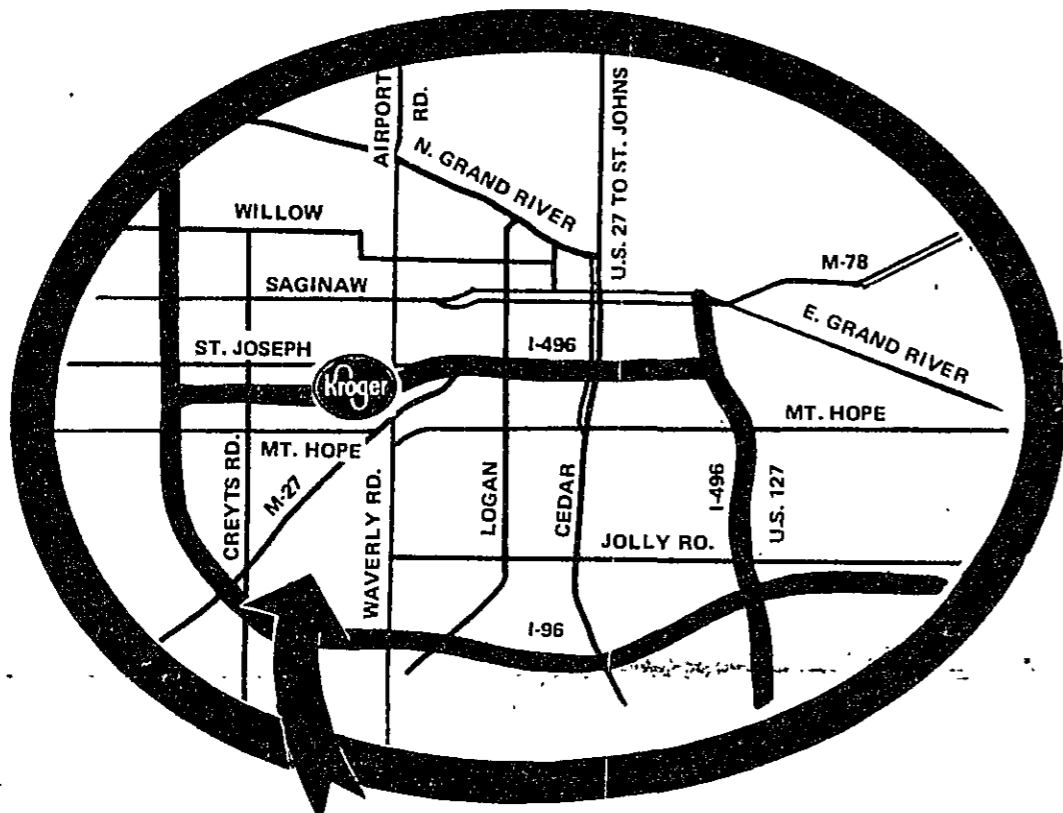

820 S. Waverly Rd.
(at St. Joseph)
Lansing, Michigan

Shop the Kroger Store nearest you.

320 Frandor, Frandor Shopping Center
1712 N. Grand River Ave.
3222 S. Logan
900 S. U.S.-27, St. Johns

Kroger VALUABLE KROGER COUPON

Kroger Pot Pies
16^c
8-Oz Pies

Limit One Coupon per Customer With \$7.50 Purchase.
Coupon Good thru Sunday, August 28 at your Lansing & St. Johns Kroger Stores Only. Subject to applicable state and local taxes.

WELCOME TO LANSING'S GREAT NEW KROGER SUPERSTORE!

Come out and see our new Kroger Superstore at 820 S. Waverly Rd., . . . one of the largest and finest Kroger stores in all of Western Michigan. You'll see for yourself what the total concept of one-stop shopping really means. And you'll save more with Kroger's Xtra-Low Discount Prices every day of the week.

Open Seven Days a Week to Serve You Better!
Monday Thru Saturday
8am to 10pm
Sunday 10am To 6pm

WIN!
a 1973
Oldsmobile Omega
or a
Color TV Set!
No Purchase Necessary

KROGER ENTRY BLANK
No Purchase Necessary

Name _____
Street _____
City _____ Phone No. _____

Kroger Co. Employees And Their Families Are Not Eligible
Winners Will Be Notified

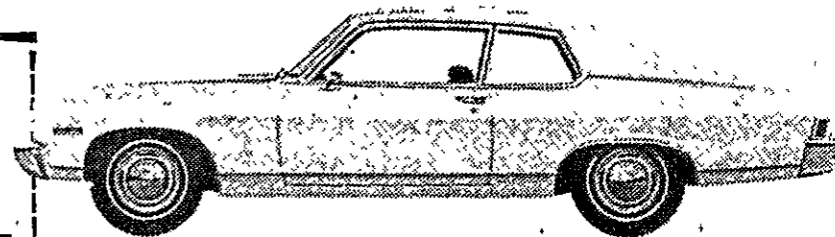

Win Your Very Own 1973 Oldsmobile Omega

First Prize in the big city-wide Superstore Grand Opening Celebration is a brand-new 2-door 1973 Oldsmobile Omega. Get in on the fun - enter now.

ENTER NOW!
Entry blanks and entry boxes are at all Lansing and St. Johns Kroger Stores. All entrants must be 18 years of age or older. Kroger Co. employees and their families are ineligible. Drawing September 8, 1973. You need not be present to win. Prizes are not transferable. No Purchase Necessary.

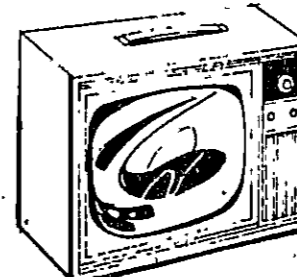

Second Prize - Color TV Set
Second prize in the Superstore Grand Opening Celebration is a brand new Sony Trinitron 12" Portable Color T.V. Set.

Condensed

Campbell's Tomato Soup

10 1/2 Oz Wt Can

8¢

Limit 3

With Coupon and \$7.50 Purchase



Assorted Flavors

Hawaiian Punch

46-Fl Oz Can

29¢



Kroger

Vac Pak Coffee

2 Lb Can

\$1.29

With Coupon and \$7.50 Purchase



U.S. Govt Inspected Fresh

Mixed Fryer Parts

Lb

59¢

Includes: 3 Forequarters with Wing & Back Attached, 3 Hindquarters with Back Attached, 3 Wings, 2 Pkg Giblets.

Lean and Meaty

Smoked Picnics

Lb

79¢

Thin Sliced Lb: 89¢

Water Added By Mfr

U.S. No 1 Michigan Round

White Potatoes

20 Lb Bag

\$1.69



25¢ Off Label

Fab Detergent

84 Oz Wt Pkg

99¢



Facial Tissue

Scotties

4 200 Ct Pkgs

\$1



Assorted

Yubi Yogurt

4 8-Oz Cartons

88¢



Kwick Krisp

Sliced Bacon

12 Oz Wt Pkg

\$1.29

All Meat

Herrud Wieners

12 Oz Wt Pkg

99¢

Quarter Pork Loin Sliced Into

Pork Chops

Lb

\$1.49

Copyright 1973. The Kroger Co. We Reserve The Right To Limit Quantities. Prices and Coupons Good August 20-26, 1973 in Lansing and St. Johns Only.

Kroger X-TRA LOW DISCOUNT PRICES And More

KEEPING POSTED

Not One Single Cent Of Any Kroger Price Increase Goes Into Kroger Profit.

The truth about food prices is that they are going to go up some. At Kroger, and at every other supermarket, because of reasons no supermarket can do anything to control. But in the end, when all the new prices are on the packages, Kroger is still going to call its prices "Discount Prices". Because that's what they'll be - compared to higher prices you can pay elsewhere. One thing you can be sure of: we're not taking even a penny of profit on any price increase we're forced to pass along. In fact we can't pass along our own increased costs on such things as wages, taxes and fuel. We wish we could promise you food prices will stay put. But you know we can't. What we can, and do, promise is to keep our Kroger prices as fair as we possibly can, and still stay in business.

We Hear You...and we're trying to help!

Save \$2.20

With These Valuable Coupons

15¢ Off
With Coupon & Purchase of One 24-Oz Carton
Kroger Cottage Cheese
Limit One Coupon per Customer. Prices Good August 20-26, 1973. Subject to applicable state and local laws.

25¢ Off
With Coupon & Purchase of \$3.00 or More
Health & Beauty Aids
Limit One Coupon per Customer. Prices Good August 20-26, 1973. Subject to applicable state and local laws.

10¢ Off
With Coupon & Purchase of Any 4-Packages
Kroger Gelatin
Limit One Coupon per Customer. Prices Good August 20-26, 1973. Subject to applicable state and local laws.

20¢ Off
With Coupon & Purchase of One Half Gallon
Kroger Deluxe Ice Cream
Limit One Coupon per Customer. Prices Good August 20-26, 1973. Subject to applicable state and local laws.

15¢ Off
With Coupon & Purchase of 2 1/2-Dozen Pkgs
Kroger Large Eggs
Limit One Coupon per Customer. Prices Good August 20-26, 1973. Subject to applicable state and local laws.

25¢ Off
With Coupon & Purchase of One 12-Oz Can
Favor Furniture Polish
Limit One Coupon per Customer. Prices Good August 20-26, 1973. Subject to applicable state and local laws.

Redeem Money Saving Coupons

Sliced-Chunk Or Crushed

Kroger Pineapple

20-Oz Wt Cans

3 \$1

Kroger Dinners

Macaroni & Cheese

6 7 1/2-Oz Wt Pkgs

\$1

Kroger Sliced

American Cheese

12-Oz Wt Pkg

69¢

Appian Way

Cheese Pizza

12 1/2 Oz Wt Pkg

3 \$1

Pre Basted

Wishbone Turkeys

Lb

79¢

10 To 14 Lb Avg

"We have "People's Choice"—U.S. Govt. Graded Choice Beef Available at all Kroger Stores."

Family Pkg

Whole Fryer Legs

Lb

79¢

Fresh Frozen New Zealand

Lamb Shoulder Roast

Lb

\$1.09

Oscar Mayer

Sliced Bacon

Lb Pkg

\$1.79

Quality and Freshness - Satisfaction Guaranteed

California

Red Ripe Strawberries

4-Size Each

99¢

Home Grown

Sweet Corn

Ear

7¢

In The Husk

Jumbo

Cantaloupe

27-Size

2 For 89¢

Wagner's

Lemon-Lime Drink

3 3-Oz For

88¢

Kroger

Tuna Magic

8-Oz Wt Pkg

39¢

Kroger

B-B-Q Sauce

3 18-Oz Wt Pkgs

\$1

Freezer Pleezer

Twin Pops

2 12-Oz Pkgs

88¢

Freezer Pleezer

Ice Cream Sandwiches

12-Ct Pkg

77¢

G & W

Cheese Pizza

16-Oz Wt Pkg

68¢

Del Monte

Snack Pack Puddings

4 Pack Cartons

2 88¢

Kroger

Pie Crust Shells

4 10-Oz Wt Pkgs

\$1

Kroger Non Dairy

Coffee Creamer

32-Oz Wt Cn

29¢

Kroger Refrigerated

Cinnamon Rolls

4 9 1/2-Oz Wt Tubes

\$1

Roman Meal

Refrigerated Biscuits

12-Oz Wt Pkg

25¢

Kroger

Half & Half

2 Quarts

\$1

Orchard Grove

Orange Juice

64-Fl Oz Cn

69¢

Random Weight

Perch Fillets

Lb

88¢

Bulk

Pre Cooked Perch

Lb

89¢

Delicious

Red Snapper Fillets

Lb

89¢

Dieter's Delite!

Boneless Turbot Fillets

Lb

79¢

\$1.79 Size Antiperspirant

Dial Deodorant

8-Fl Oz Can

89¢

99-Size

Polident Tablets

Pkg Of 28

63¢

Oscar Mayer All Meat or

All Beef Bologna

8-Oz Wt Pkg

79¢

Oscar Mayer

All Beef Franks

Lb

\$1.29

Herrud

Party Assortment

Lb

\$1.49

Herrud Bulk

Ring Bologna

Lb

\$1.29

Washington

Purple Plums

3 Lbs

\$1

First Of The Season

Home Grown

Green Peppers

2 For

29¢

Fresh Sno-White

Mushrooms

Lb

69¢

Michigan Red Haven

Peaches

Lb

29¢

Wagner's Breakfast

Orange Drink

64 Fl Oz Btl

55¢

Bird's Eye

Frozen Peas Or Corn

10-Oz Wt Pkg

5 \$1

Royal Viking

Danish Pastry

2 Packages

\$1

Breakfast Drink

Birds Eye Awake

12 Fl Oz Can

3 \$1

*1.13 Size

Close-Up Toothpaste

6.4 Oz Wt

69¢

Blue Bonnet

Margarine

2 8 Oz Wt Pkgs

36¢

With Coupon and \$7.50 Purchase

Home Grown

Cucumbers

2 For

29¢

Home Grown Michigan

Tomatoes

Lb

29¢

Red Ripe

Watermelon

20-Lb Avg

99¢

Valuable Kroger Coupon

20¢ Off

With Coupon & Purchase of Two 1-Lb Pkgs

Kwick Krisp Bacon

Limit One Coupon per Customer. Prices Good August 20-26, 1973. Subject to applicable state and local laws.

Valuable Kroger Coupon

20¢ Off

With Coupon & Purchase of 2-Lbs or More

Pork Steak

Limit One Coupon per Customer. Prices Good August 20-26, 1973. Subject to applicable state and local laws.

Valuable Kroger Coupon

20¢ Off

With Coupon & Purchase of 1-Pkg Quarter Loin Sliced Into

Pork Chops

Limit One Coupon per Customer. Prices Good August 20-26, 1973. Subject to applicable state and local laws.

Valuable Kroger Coupon

50¢ Off

With Coupon & Purchase of One 3-Lb Size Serve-N-Save

Canned Ham

Limit One Coupon per Customer. Prices Good August 20-26, 1973. Subject to applicable state and local laws.

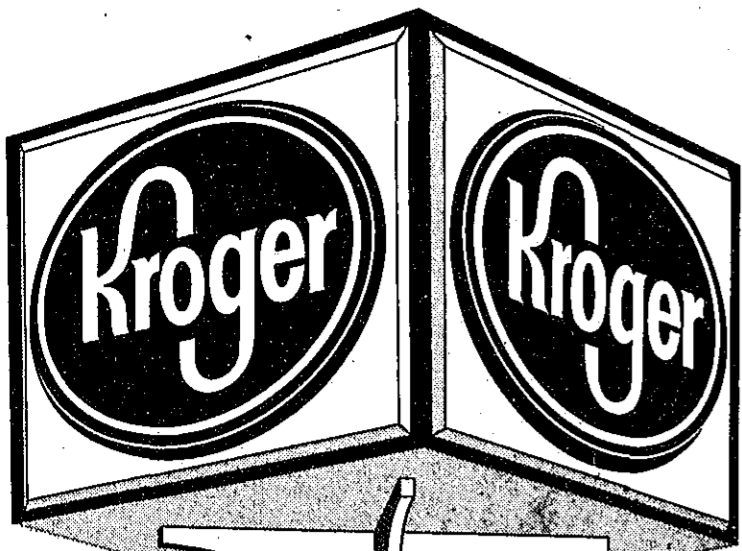

You're invited to shop the newest, largest most complete Kroger Superstore in Lansing!

Copyright 1973, The Kroger Co. We Reserve The Right To Limit Quantities.

Prices and Coupons Good thru Aug. 20-26, 1973 in Lansing Superstore Only.

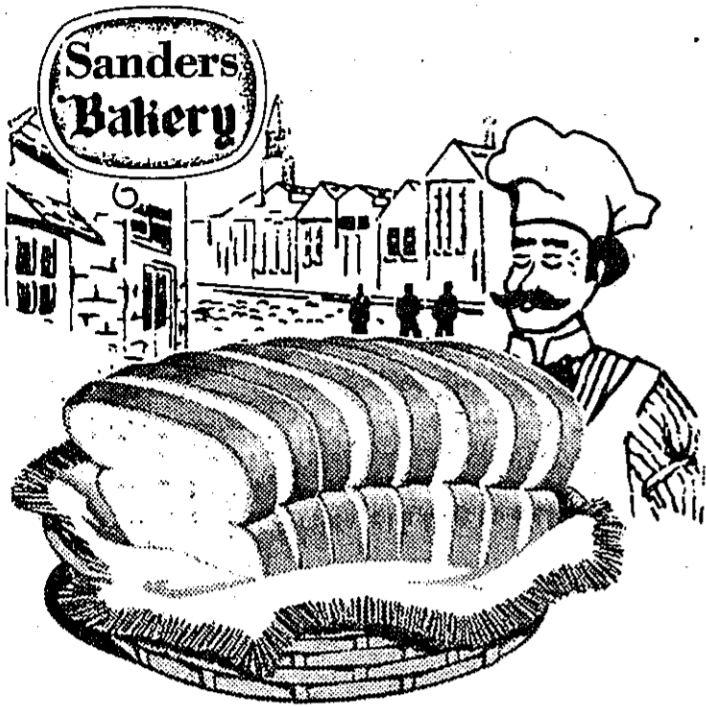

Sander's Superstore Bakery

Looking for old-fashioned, fresh-from-the-oven quality? Look no further than your Superstore Sander's Bake Shop. We've got full variety in fresh-baked rolls, breads, pastries and doughnuts. Country bake shop quality at Xtra-Low Discount Prices. . . only at your Sander's Superstore Bake Shop.

Curly-Q Fried Cakes



8 For 59¢

Milk or Swiss
Chocolate Fudge Topping

20-Oz Jar **97¢**

German
Sweet Chocolate Layer Cake

2 Lb 5-Oz **\$1.89**

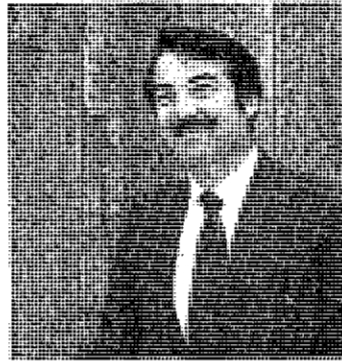
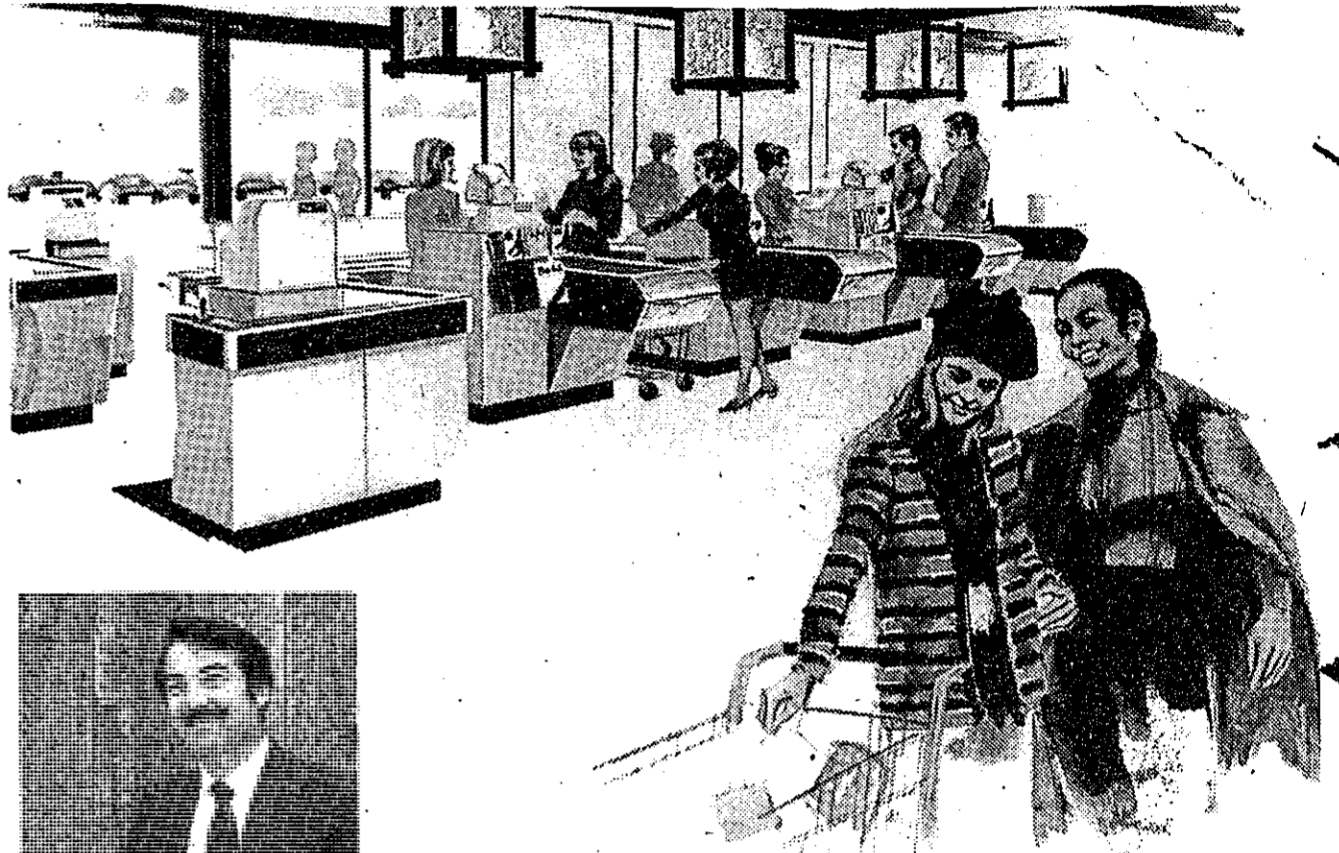

Pat Lawrence
Store Manager

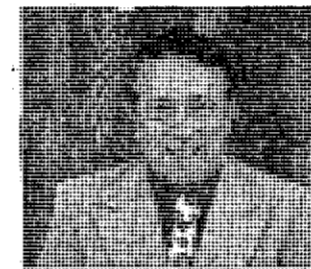

Jack Jackson
Co-Manager



Charlene Hansen
Co-Manager

You are cordially invited . . .

Welcome to your new Kroger Superstore. It is our pleasure to offer you the most modern, most complete supermarket in the area. To go with the beautiful store, we hope you'll find our fast service and friendly atmosphere to your liking. It is our endeavor to serve you and this community to the best of our abilities.

Come in and see how you can have quality, value, service, unbelievable variety and Xtra Low Discount Prices - all in a relaxed enjoyable atmosphere.

Welcome Kroger Shoppers to the Deli Department

Chicken Jamboree

SAVE \$1.00

Crispy Golden Chicken

15 Pieces **\$4.99** Free! **With Coupon**

Cole Slaw & 6 Dinner Rolls with purchase of 15 pieces.

\$1 OFF
on 15 pieces of
CRISPY GOLDEN CHICKEN
With this Coupon - \$4.99
Without this Coupon - \$5.99
Limit 1 Coupon, Good Monday Aug. 20, thru Sunday, Aug. 26.
Subject to applicable state and local taxes.

Imported Sliced

Picnic Ham

99¢

Kidney Beans
V & O Salad

49¢

Longhorn
Colby Cheese

69¢

Fresh Baked
Peach Pie

79¢

Herrud All Meat
Bologna

1.19

Here are some of the friendly people at your service at Kroger in Lansing



FRANCA OSBORN
Non Foods Coordinator



ANNA ZIVIC
Health and Beauty Aids Coordinator



JACK FITZGERALD
Head Produce Clerk



BOB SMITH
Head Dairy Clerk

Here are just a few of the things that make a Kroger Superstore Special



Health Foods

The foods usually used to help retain, rather than restore, good health. Our health foods are processed without preservatives, and whenever possible, they are grown without the use of chemical fertilizers, herbicides, insecticides or anything not found in nature itself.



Diet Foods

Watching inches and Watching pounds? Watching pennies? Look no further! At your Kroger Superstore you'll find an entire department devoted to dietetic foods at Xtra Low Prices.



Gourmet Foods

Select from an extensive variety of exciting gourmet foods at our new Superstore. You'll find imported fish delicacies and caviar, imported teas, dried biscuits, smoked oysters, mineral water and dozens upon dozens of foods rarely seen in the average supermarket.

NEW!

the market

Now!



place

Call
224-2361
TO PLACE YOUR
CLASSIFIEDS NOW!

Section C

August 23, 1973

SERVING OVER
12,000
CLINTON AREA FAMILIES

Covering six St. Johns rural routes, two Fowler rural routes, Village of Fowler, Village of Ovid, two Ovid rural routes, DeWitt Route 1, City of DeWitt and Village of Westphalia plus the regular circulation of the Clinton County News each week.

Help Wanted 1

WANTED — Registered nurses, part time on 7 to 3 shift, full time and part time on 3 to 11 shift and 11 to 7 shift. Every other weekend off. Please call Gratiot Community Hospital, 300 Warwick Dr. Alma, Mich. Phone 517-463-1101 ext. 246. An equal opportunity employer. 14-tf-1

WANTED — Reliable lady to care for children and housekeeper. Call 669-5692 or 482-3596. 15-3-p-1

HELP WANTED — Full-time registered nurse for Mid-Michigan District Health Department, Clinton County Branch Office. Call for interview. Phone 224-7772. 17-3-p-1

WANTED — Office manager, bookkeeper and general office work. St. Johns area. Good pay and benefits. Call Lansing 393-5437 for appointment. 15-3-p-1

SECRETARY WANTED — Must be good typist and be familiar with office machines. Call 224-3288 for appointment. Clinton County Extension Service an equal opportunity employer. 16-2-p-1

GOSPEL CONCERT — with the Gospel Troubadours. Ithaca Fall Festival, Saturday Aug 25, 1973, 8:30 pm behind Ithaca Commercial Nat Bank. 16-2-dh-1

NO EXPERIENCE? We will train you to Sell Toys & Gifts. *Top Hostess Program, *No collecting, *No delivery, *Top Pay PLUS Bonus, *Free kit. Merri-mac Toy Shows, 484-3034 Lansing, 627-9254 Grand Ledge, 625-3404 Perry. 16-4-p-1

NOON-TIME cook wanted. Apply in person at L & L Restaurant. 318 N. Clinton. St. Johns. 17-3-p-1

QUANTITY RIGHTS RESERVED

Your Thrifty Food Markets

MAHARS SUPER MARKET
in POMPEII
"SHOP & SAVE THE MAHAR WAY"

Shoulder **SPARE RIBS** -Neck Cuts- **69¢**

Club **FRANKS** \$1.09 lb. Mich. Grade 1

Tasty All Beef ONION **STEAKS** \$1.39 lb.

Farmer Peets Ring **BOLOGNA** \$1.19 lb. Mich. Grade 1

Fresh Dressed **FRYERS** 69¢ lb. Grade A

FREE LOTTERY TICKET With \$25.00 Purchase Excluding Beer, Wine & Cigaretts

CANNING & PICKLING SUPPLIES

Thin Fould **SPAGHETTI** or **MACARONI** 2 lbs. 49¢

Star Kist **TUNA** 2/89¢ 6 1/2 oz. Can

Orange or Grape **CRUSH** 12 oz. cans 6/79¢

Chef-Boy-Ar-Dee **SPAGHETTI SAUCE** 39¢ 16 oz.

AJAX DETERGENT 5 lb. 1 oz. Box 99¢

Sani Kleen **TRASH LINERS** 50 ct. \$1.79

Tortina **PIZZAS** 69¢ Cheese, Hamburger, 14 oz. Sausage

Delta Toilet **TISSUE** 3/\$1 4 roll pack

PIERCE BAKERY BUYS AT MAHARS

Ocean **PERCH** 79¢ lb.

Large, Solid **HEAD LETTUCE** 29¢ Each

Homegrown Honeyrock **MELONS** 39¢ Each

Classified ads get the job done

WANTED — Administrator for Crisis Intervention Center serving Clinton County. Prior experience working with crisis situations and with people of varying backgrounds and ages preferred. Good salary. Applications available at 300 E. Sturgis St., St. Johns, 48879. Ph. 224-6729. 16-3-p-1

PART-TIME HELP in telephone room of Sears Roebuck & Co. Southgate Plaza St. Johns. Apply in person. 17-3-p-1

DRIVERS — Needed for Jumbo Ice Cream Trucks. Male or female. Apply at 11390 N. US-27 DeWitt. 17-1-p-1

FACE UP
A little reflection will bring to light the things that have kept you down in the dumps.

Business Opportunity 2

QUEEN'S WAY to fashion-dealer wanted. Call 224-4026 for details. I am also looking for parties. 15-3-p-2

A PLEASANT, exciting and profitable business opportunity in Home Care Products and Food Supplements. For information call 651-5529 between 5-7 p.m. 15-3-p-2

SALESMEN: Find out about the challenging career opportunities with IDS. We sell Face Amount certificates, Life Insurance, Mutual Funds, oil and gas limited partnership, etc. Annualized commissions. Call Mr. Meyers, 482-5565, 484-9448 after 5 PM. 17-10-p-2

Jobs Wanted 3

JOBS WANTED — Painting, very reasonable and responsible for a house or out buildings, machinery, fences, boat, anything large or small. 224-4537. 16-3-p-3

WANTED — Children to care for in my country home. Reasonable rates. Can furnish references. 834-5718. 16-3-p-3

WHITE WASHING TIME is here again. Call B.G. Schafer, Pewamo 517-593-3550. 17-1f-3

Real Estate 4

FOR SALE — Modern 9 room ranch home with 3 bedrooms, 2 baths, laundry room, basement, plenty of closet space, attached double car garage with extra storage space, large lawn, on four acres located outside Ovid Village on N Hollister Road. Call 834-2375 after 3:30 pm or weekends. 8f-4

FOR SALE — Ovid. Be in before school starts. 2 story, 3 to 4 bedrooms, large lot, nice neighborhood, 2 car garage. For sale by owner. 217 West St. Call 834-2644 or 834-2218. 13-4-p-4

FOR SALE — Long 20 acres for sale on Loomis Rd. Section 17, Olive Township. We would like cash offer. Write Box D c/o Clinton County News. 15-3-p-4

FOR SALE — Older home, 5 bedrooms, 2 full baths, fully carpeted, attached garage, located at 410 S. Oakland, St. Johns. See by appointment only. Call Westphalia 587-6851. 15-3-p-4

WE, OURSELVES, will buy your land contract. For prompt, courteous action, call Ford S. LaNoble, 517-593-3550. 17-1f-4

LaNoble Realty, 1516 E. Michigan, Lansing, Phone (517)-482-1637. Evenings (517)-337-1276. 37-tf-4

FOR SALE — 3 bedroom older home, zoned commercial, can arrange financing. 1001 E State. 8f-4

4 NEW HOMES under construction in Westphalia and surrounding area for sale. Call Fedewa Builders, Inc. 587-3811. 42-tf-4

BUILDING LOTS available in Ovid area. Will build using your plans or ours. Fedewa Builders, Inc. 517-593-3550. 17-1f-4

ONE LOT FOR SALE on Lehman Road. Will build using your plans or ours. Will help arrange financing. Call Fedewa Builders, Inc. 587-3811. 28-tf-4

TO SETTLE ESTATE — Small 5 room house, garage on large lot, one block east on M-21, Fowler. 593-3616. 16-3-p-4

LAND — Buying or selling, call Keith Bunce for dependable service. Lots, land parcels, farms industrial or commercial sites. Robert Strong Realty 371-2330 or 489-3465 or 489-7640. 16-3-p-4

WESTPHALIA — Three-bedroom ranch home with attached garage. Inside village limits of Westphalia. Call 587-4372. 17-3-p-4

HOUSE FOR SALE — 4 bedrooms, carpeted kitchen, dining room, and bathroom. Garage, large fenced-in backyard. 304 S. Mead, St. Johns. Phone 224-7887. 17-1-p-4

10 ACRES for sale by Airport and Colony. \$7,000. 224-2487. 110 E. Lincoln. 17-3-p-4

FOR SALE — New house on corner of Johnson Rd. and US 27, 1-1/2 acres of land, 3 bedrooms, with full

basement. Also, 3 homes for sale on Airport Rd., 1/4 mile south of Kinley Rd. One beautiful home sets on 10-1/2 acres of land featured by a walkout sundeck on the upper level and a walkout basement with sliding glass doors onto a patio. Also highlighting this beautiful setting is a pond. The other 2 homes are near completion and set on 1 acre lots. Call 224-3427 or 224-3910. 17-3-p-4

FOR SALE — Completely remodeled 3 bedroom house with new gas furnace. 834-2495. 17-1-p-4

FOR SALE — 3 bedroom completely furnished. Will sell for balance owed. Phone 669-9150. 14-p-3-10

FOR SALE — 1970 Trotwood mobile home. 12'x60'. Air conditioned, washer, dryer, disposal, built-ins, shed and more. Call 224-6048 or 224-3437. 16-2-p-10

FOR SALE — Parkwood. 1969 12'x60', 2 bedroom, unfurnished. Call 224-2458 or 224-3086. 16-3-p-10

FOR SALE — 1970 Chevrolet Impala. V-8, Custom Coupe. Radio. 587-6874. 17-1-p-11

FOR SALE — 1972 Chevrolet pickup, 1/2 ton, 23,000 miles heavy rear spring, front stabilizer, radio, V-8 automatic. Zeibart undercoat, step-up rear bumper, extra wide turf tires. Ladder racks. \$2400. Phone 224-6332. 17-3-p-11

NEW COTTAGE AND WOODED LOT — 10% down. Easy terms. Share private sandy beach on large lake. Individual boat tie-up. Near thousands of acres of State Land. Excellent fishing and hunting area. Take Freeway to our office on Bus. US-27 (I-75) across from Wilson State Park, north side of city. Progress brings many problems — no problems, no progress.

LOT FOR SALE AT Rainbow Lake by owner. 593-3122. 16-3-p-5

FOR RENT — 6 COUNTRY HOME — For Rent with other buildings. Call 847-2655 or 862-5379. 17-1-p-6

FOR RENT — 6 MOBILE HOMES 10

FOR RENT — 6

Open 7 days a week. Northern Development Co., Harrison. (Member Chamber of Commerce). 16-3-p-5

NORTHERN MICHIGAN PROP. — 10 acre parcels in Elk Country, while they last. Some with stream, some joining State Land. All have good access roads. Prices start at \$4900.00. All have Title insurance and are surveyed. Call or write: Ben Schenck & Assoc., Inc., 200 Main St., East Jordan, MI. 49727 (616) 536-7641. 17-4-p-5

FOR RENT — 6

FOR RENT — 6

FOR RENT — 6

FOR RENT — 6

FOR RENT — 6

FOR RENT — 6

FOR RENT — 6

FOR RENT — 6

FOR RENT — 6

FOR RENT — 6

FOR RENT — 6

FOR RENT — 6

FOR RENT — 6

FOR RENT — 6

FOR RENT — 6

FOR RENT — 6

FOR RENT — 6

FOR RENT — 6

FOR RENT — 6

FOR RENT — 6

FOR RENT — 6

FOR RENT — 6

FOR RENT — 6

FOR RENT — 6

CLASSIFIED AD PAGES
CASH RATE 5¢ per word
Minimum 50¢ per insertion

Save a 25¢ service fee by paying for your charged ad within 10 days of insertion.

BOX NUMBERS in care of this office add \$1.00

ALL CLASSIFIEDS WILL BE ACCEPTED UNTIL MONDAY AT 5 P.M.

RATES are based strictly on Classified Style FOR FAST RESULTS—PHONE 224-2361 OR ENTERPRISE 8201

Automotive 11

FOR SALE — 1962 Ford pickup, 1 ton, 4 speed. Good tires. Call 587-6851. 15-3-p-11

FOR SALE — 1964 Ford Station wagon. \$85.00. Ph. Laingsburg 651-5722. 16-3-p-11

FOR SALE — 1968 Dodge Polara, automatic, radio, good condition. 834-2842. 16-3-p-11

FOR SALE — 1970 Chevrolet Impala. V-8, Custom Coupe. Radio. 587-6874. 17-1-p-11

FOR SALE — 1972 Chevrolet pickup, 1/2 ton, 23,000 miles heavy rear spring, front stabilizer, radio, V-8 automatic. Zeibart undercoat, step-up rear bumper, extra wide turf tires. Ladder racks. \$2400. Phone 224-6332. 17-3-p-11

FARM and INDUSTRIAL TRACTORS and EQUIPMENT New and Used

Simplicity

LAWN and GARDEN EQUIPMENT

HENGESBACH FORD TRACTOR SALES

Phone 647-6356

PORTLAND, MICH. 51-tf

Symbol of Service

200 W. State St.

PHONE 224-2301

The Briggs Company

RETIRES

ST. JOHNS MICHIGAN

COUNTRY LOVERS 2 story 4 bedroom home offering a pleasant spot. Lots of storage space, play house in back yard for the tots, large garage, 1 acre south of St. Johns. \$24,500.00. #557

LOOKING FOR AN OLDER HOME in good repair? We have just the place at 207 S. Swegles, 3 bedrooms, fully insulated, drapes & curtains stay, refrigerator & stove in large kitchen. Immediate possession. \$25,300.00. #168

NEW LISTING 509 W. State. 4 bedrooms with many extras, large fenced yard with patio. Dishwasher, disposal, stove & refrigerator included. Dining room, 2 car garage, 1st floor laundry. \$25,000.00. #173

LOCATE NEAR THE PARK in this beautiful 3 bedroom ranch, with large family room with patio, large carpeted living room, beautiful kitchen with built-ins, 1-1/2 baths also main floor laundry, 2 car attached garage. Make appointment to see. #170.

911 E. CASS STREET — Really a nice neighborhood and an extra large lot makes it all worthwhile. 3 bedrooms, nice size living room, plenty of cupboard space in kitchen, 2 car garage. Just \$31,900.00. #155

WILL CONSIDER TRADE on your home on this fine new colonial. 3 large bedrooms upstairs with full 4 pc. bath, family room down with sliding glass doors to patio, main floor laundry, full basement, 2 car garage, corner lot. #118

210 N. TRAYER — Real neat 4 bedroom Cape Cod has new siding, lovely carpeted living room 13x22, main floor laundry room, beautiful yard. Priced to move into.

FOR APPOINTMENTS AT OTHER TIMES PHONE:

Need Concrete?

CALL KARBER'S

224-6776

FOR APPOINTMENTS AT OTHER TIMES PHONE:

Annette White 224-4296
Bruce Lanterman 224-4746
Derrill Shilberg 224-3881
Bill Holley 224-7580
or 862-5391
Pat & Ruth Lusk 669-9228
Roy F. Briggs 224-2260
Randy Briggs 224-6074
Member of Lansing Board of Realtors

Harr's Jewelry

presents...
for that someone Special

No. 54143M-174.
Self-Wind, Instant Day-Date,
Bilingual English-Spanish Calendar,
98 2 Ft. Water Tested, Stainless Steel,
Blue Dial. \$89.50

14K GOLD
from \$125 up

Available in Yellow or White
LOVE!! SAY IT WITH DIAMONDS!
Visit the Diamond Department

and see our many stunning new styles of Diamonds. We have much more to offer in style, quality and price. See for yourself, compare. Never a charge to clean and check over diamonds after the sale. ANY CREDIT TERMS AVAILABLE. NO CARRYING CHARGES.

Open 6 Days A Week, Mon. & Fri. Nights til 9

ST. JOHNS
PHONE 224-7443

CLASSIFIED BUSINESS SERVICE DIRECTORY

Use This Classified Listing For Fast Service From Clinton County Business Firms

<p>ARTS & CRAFTS</p> <p>NEEDLE ARTS, 701 S. Kibbee Ph. 224-2956. Needle point, crewel embroidery, rug hooking.</p>	<p>HETTLER'S MOTOR SALES, 24 Hr. Wrecker Service, Good Used Trucks.</p>	<p>FOODS</p> <p>ANDY'S IGA, St. Johns, Home Baked Bread, Pies, Cookies, Choice Meats, Carry-out service.</p>	<p>PLUMBING</p> <p>DUNKEL PLUMBING AND HEATING, Licensed Master Plumber Ph. 224-3372, 807 E. State St.</p>
<p>AUCTIONEER</p> <p>A L GALLOWAY, AUCTIONEER Used Farm Machinery & Parts. St. Johns, 224-4713.</p>	<p>BARBERS</p> <p>BEAUFORT'S BARBER SHOP, 1002 1/2 State. Open Tues. thru Sat. also Wed. & Fri. evenings.</p>	<p>GIFTS</p> <p>THE TREASURE CHEST, 220 N. Clinton, Hollmark Cards - Russell Stover Candy.</p>	<p>REAL ESTATE</p> <p>BURTON ABSTRACT AND TITLE CO. Abstract and Title Services, 119 N. Clinton. Ph. 22-3294.</p>
<p>AUTOMOTIVE</p> <p>BILL FOWLER FORD, New & Used Cars & Pick-ups. N. US-27, DeWitt, 669-2725.</p>	<p>CLEANERS</p> <p>ANTES DRY CLEANERS, pickup and delivery, 103 W. Walker, phone 224-4529.</p>	<p>HARDWARE</p> <p>DALMAN HARDWARE, Ph. 669-6875, DeWitt, Whirlpool Appliances, Zenith TV, Plumbing and Heating.</p>	<p>RESTAURANT</p> <p>DALEY'S FINE FOOD, Dining & cocktails, Ph. 224-3072, S. US 27 1/2 mile S. M-21.</p>
<p>CAIN — BUICK — PONTIAC, New & Used Cars, 210 W. Higham, Complete Body & Service.</p>	<p>DRUGS</p> <p>PARR'S REXALL DRUGS, open daily 7:30 a.m. to 9 p.m., Sunday 8:30-12:30 & 5-9 p.m.</p>	<p>INSURANCE</p> <p>JIM MCKENZIE INSURANCE, All Lines of Ins. 224-2479 Ionia 527-2480.</p>	<p>VACUUM SALES</p> <p>KIRBY CENTER OF ST. JOHNS, Vacuum Sales and Service moved to new location at 705 N. U.S.-27 formerly known as the Aloha Drive-In. 224-7222.</p>
<p>EGAN FORD SALES, INC., 200 W. Higham, phone 224-2285. Pinto-Ford-Maverick-Torino-Mustang.</p>	<p>ELECTRICIANS</p> <p>SCHMITT ELECTRIC CO., Residential - Commercial - Industrial, 224-4277, 807 1/2 E. State St.</p>	<p>JEWELRY</p> <p>LEVEY'S JEWELRY, Orange Blossom diamond rings, Bulova & Accutron Watches. Elsie, 862-4300.</p>	<p>WESTERN</p> <p>TOM'S WESTERN STORE, 1 mi. W. Ovid, 9-5:30 Mon.-Sat., Fri. til 9. Anytime by Appt. 834-5446.</p>
<p>HUB TIRE CENTER, B.F. Goodrich Tires, Ph. 224-3218, Front End Alignment.</p>	<p>FERTILIZERS</p> <p>ZEEB FERTILIZERS, Everything for the soil, St. Johns, 224-3234, Ashley, 847-3571.</p>	<p>MASONRY AND CEMENT</p> <p>Sam Van Etten 224-4067</p>	<p>FOR ALL YOUR CLASSIFIED NEEDS CALL 224-2361</p>
<p>BOB'S AUTO BODY, Complete Collision Service, 224-2921, 800 N. Lansing.</p>	<p>FINANCIAL</p> <p>CAPITOL SAVINGS & LOAN ASSOC., 222 N. Clinton, 224-2304, Safety for Savings since 1890.</p>	<p>PARTY SUPPLIES</p> <p>D & B PARTY SHOPPE, Package Liquor 9 a.m. - 10 p.m. Mon. Thurs. Fri. & Sat. 9 a.m.-11 p.m., 224 N. Clinton.</p>	<p>CALL 224-2361</p>
<p>HENRY E. DREPS, INC., Cars, Trucks & Motor Home Serv. 11375 N. US-27, 669-9996.</p>	<p>FLORISTS</p> <p>Say it with Quality Flowers from WOODBURY'S FLOWER SHOP, 321 N. Clinton, St. Johns, 224-3216.</p>	<p>MOORE OIL CO., If it's tires, see us, 909 E. State, Ph. 224-4726.</p>	<p>CALL 224-2361</p>

Best USED CAR BUYS in town

<p>73 MODELS</p> <p>CHEVROLET CAMARO auto., PS & PB, 3,000 miles</p>	<p>71 MODELS</p> <p>OLDSMOBILE CUTLASS WAGON A Red Beauty! V-8, auto</p>
<p>PONTIAC LE MANS SPORT 2-dr. H.T., auto, PS & PB, Air</p>	<p>BUICK CENTURION 2-dr. H.T., Air, AM-FM</p>
<p>BUICK CENTURY 2-dr. H.T., 5,000 miles, sharp!</p>	<p>BUICK ESTATE WAGON Air, stereo, much more!</p>
<p>BUICK LE SABRE CUSTOM 4-dr. H.T., climate control, 5,000 miles</p>	<p>PONTIAC FIREBIRD Rally Wheels, PS & PB, Auto</p>
<p>PONTIAC CATALINA 4-dr., Demo with Air!</p>	<p>CHEVROLET NOVA 6 cyl., one owner and sharp!</p>
<p>BUICK ELECTRA 225 CUSTOM 4-dr. H.T., Loaded with luxury! Mr. Cain's Demo</p>	<p>70 MODELS</p> <p>OLDSMOBILE CUTLASS SUPREME 2-dr. H.T., Air, auto</p>
<p>72 MODELS</p> <p>CHEVROLET IMPALA CUSTOM 2 dr. H.T., 14,000 miles and sharp!</p>	<p>FORD MUSTANG SPORT COUPE Small 302 V-8</p>
<p>EL CAMINO auto., V-8, vinyl top</p>	<p>OLDSMOBILE 98 LUXURY 4-dr. H.T., Air and loaded!</p>
<p>OPEL SPORT WAGON auto, baby blue color. A real gas saver!</p>	<p>PONTIAC LE MANS 2-dr. H.T., V-8, auto.</p>
<p>FORD BRONCO 4-wheel drive, V-8, 10,000 miles</p>	<p>FORD FALCON 6 cyl., Special Priced at \$895!</p>

BUICK PONTIAC GMC OPEL

S. U.S. 27 Ph. 224-2010

CAIN ST. JOHNS

210 W. Higham Ph. 224-3231

Need Concrete?

CALL KARBER'S

224-6776



GO CLASSIFIED FOR THE ACTION YOU WANT

FOR SALE — 1964 Chevy 283 Automatic. Right rear door wrecked. Good cruising car. Call 834-5081 in Ovid. Asking \$200. 17-3-p-11

FOR SALE — 1964 Dodge 1-ton stake truck. Can be seen at 1240 Jason Rd. 17-3-p-11

FOR SALE — 1965 Ford Galaxie 500. Good condition. \$300.00. 669-3804. 16-3-p-11

FOR SALE — 1966 Ford V-8 engine. In good condition. Call 593-3152 after 5:30 p.m. 17-3-p-11

FOR SALE — 1972 Nova. 350 headers. Automatic. G60 14 on mags. Call 626-6053. 17-3-p-11

FOR SALE — 1973 Corvette convertible. Silver metallic, black top, 350 cubic inch, automatic transmission, power steering, brakes, windows, tilt telescope steering wheel, AM/FM radio. Best offer over \$5100. Phone 332-5449. 17-3-p-11

FOR SALE — Cutlass 442, 1969 convertible, silver metallic, black top, AM radio, tilt steering wheel, rally pack, posit trace, power steering, brakes, windows, air shocks, new tires. Best offer over \$2,200. 224-7902. 15-3-p-12

\$1300.00. Ph. 332-5349. 17-3-p-11

Motorcycles 12
FOR SALE — Mini-bike. 4 horsepower. Excellent condition. \$55.00. 669-3721. 17-1-p-12

FOR SALE — 1970 Suzuki TS 90. 4400 miles, excellent condition, many extras. 682-4395. 15-3-p-12

FOR SALE — 1972 Harley Electra - Glide. Saddle bags, windshield, luggage rack. Lots of extra chrome. Less than 4,000 miles. Will take \$2,200. 224-7902. 15-3-p-12

Snowmobiles 14
FOR SALE — 1973 John Deere Snowmobile. 28 horse, speedometer, double trailer and cover. 224-4008. 15-3-p-14

FOR SALE — 1973 John Deere Snowmobile. 28 horse, speedometer, double trailer and cover. 224-4008. 15-3-p-14

Sporting Goods 15
GUN SALE — New and used Winchester, Marlin, Savage, Mauser, Rueger, Ithaca. Big discounts. Smitty's. US-27 north of DeWitt. 669-3136. Open evenings. 17-3-p-15

Farm Machinery 18
FOR SALE — Knight Chopper, rack with 3 beaters. 1971 nearly new, excellent condition. \$1100.00. Call Earl Barks. 669-9213. 15-3-p-18

Farm Machinery 18
FARM MACHINERY BOOMS RED & WHITE TOP SILOS: Now in our 45th year serving the more aggressive and cost conscious farmers. Silos for every purpose. Get all the facts before you buy. Find out what a really heavy plaster coat is. Is it applied with a cement gun for better adhesion and a much much heavier plaster lining inside like we do? We install the foundation. Our trucks are self unloading with hydraulic booms. Silo-Matic and VanDale equipment. Order now and avoid the fall rush. Booms Silo Co. Inc. Harbor Beach, MI, 48441. Phone (517) 479-6554, or contact Jim O'Connor, St. Johns, MI. 48879. Phone: 224-7414. 10-1f-18

Farm Machinery 18
BEHLEN CORN CRIBS — Heavy steel rods welded and dip galvanized for years of rust-free service and high resale value. Will stand high winds even when empty. See the various sizes available in stock for immediate delivery at Fedewa Builders, Inc., 6218 Wright Rd., Fowler. Limited supply at pre-season prices. Financing available through your ASC office at 6% interest. 17-15-18

Farm Produce 19
FOR SALE — Sweet corn at the farm. Elwood Reame 5-1/2 miles north of Fowler. 682-4491. 15-3-p-19

CULTIVATED BLUE BERRIES — Pick your own or ready pick. Excellent picking. Open 7 days a week. 8:00 a.m. until dark. Belding north 3 miles on M-91. Phone 794-0348 or 754-3684. Bird Blueberry Plantation. 17-1f-19

Hogs & Sheep 20
FOR SALE — Yorkshire boar. Call 587-6874. 17-1-p-20

Cattle 21
FOR SALE — Angus Bulls service age. Stanley Geller, 3541 W. Price Rd. 16-3-p-21

FOR SALE — 3 year old registered Charlois bull for sale. 669-3275. 15-3-p-21

Pets 23
FOR SALE — 3 AKC registered male beagles. 5 months old. Ready to start hunting this fall. 224-3347. 14-3-p-23

LOST — Black cat with amber eyes. Lost north end of St. Johns around July 26. Answers to the name of "Peanuts". Reward. Call Lansing 371-1351 days ask for Mike. 15-3-p-23

FOR SALE — Pets - Labrador Retriever and German Shepherd crossed. Good with children. Mother is excellent watchdog. 338-4451. 15-3-p-23

LOST — Black on white male cat with ID tag "Ozone". Reward. McNeil Rd. 224-6014. 16-3-p-23

MUST GIVE AWAY! PUPPIES! Part cocker, part beagle. Makes good pet as they won't be large. Mother and father are excellent with children. All black. Won't be ready to take from mother until first week in September but call now so you will be sure to have one. Call 224-7502 after 5 p.m. or can be seen at 203 E. Oak St., St Johns. 16-1f-dh-23

FOR SALE — Miniature Schnauzer puppy. AKC. Reasonable. Terms available. 10 weeks old. 669-3963 or 485-6784. 17-3-p-23

FOR SALE — AKC Registered Golden Retriever Puppies. 8 weeks old. 224-2582. 17-3-p-23

GUIDANCE — The example we set for our children makes a deeper impression than our instructions.

TO BE GIVEN AWAY — 4 puppies to good home. Can be seen at 1240 Jason Rd. 17-3-p-23

Horses 24
FOR SALE — One mare. Good with children. One blue sparkly western stretch pants. Good condition. Easy to clean. 2105 N. Ovid Rd. 834-2628. 15-3-p-24

Garage Sale 25
FOR SALE — Thursday and Friday 1 mile east of St. Johns, 2088 E. M-21 men and women's clothing, antique secretary, stove, sewing machine, and many other items. 17-1-p-25

BASEMENT SALE 25
August 20-25. 9-8 5635 E. Wildcat Rd., 4-1/2 miles east of St. Johns. Lots of childrens and womens clothes. Variety of baby furniture, 2 riding lawn mowers, and kick-knacks. 17-1-p-25

Garage Sale 25
FOR SALE — Thursday and Friday 1 mile east of St. Johns, 2088 E. M-21 men and women's clothing, antique secretary, stove, sewing machine, and many other items. 17-1-p-25

Garage Sale 25
FOR SALE — Thursday and Friday 1 mile east of St. Johns, 2088 E. M-21 men and women's clothing, antique secretary, stove, sewing machine, and many other items. 17-1-p-25

Garage Sale 25
FOR SALE — Thursday and Friday 1 mile east of St. Johns, 2088 E. M-21 men and women's clothing, antique secretary, stove, sewing machine, and many other items. 17-1-p-25

Garage Sale 25
FOR SALE — Thursday and Friday 1 mile east of St. Johns, 2088 E. M-21 men and women's clothing, antique secretary, stove, sewing machine, and many other items. 17-1-p-25

Garage Sale 25
FOR SALE — Thursday and Friday 1 mile east of St. Johns, 2088 E. M-21 men and women's clothing, antique secretary, stove, sewing machine, and many other items. 17-1-p-25

Garage Sale 25
FOR SALE — Thursday and Friday 1 mile east of St. Johns, 2088 E. M-21 men and women's clothing, antique secretary, stove, sewing machine, and many other items. 17-1-p-25

Garage Sale 25
FOR SALE — Thursday and Friday 1 mile east of St. Johns, 2088 E. M-21 men and women's clothing, antique secretary, stove, sewing machine, and many other items. 17-1-p-25

Miscellaneous 27
MIKE'S STORE — 10 a.m. - 5 p.m. New and used items. Also wallpaper goldfish, and guppies - .35. 1967 Ford Fairlane, good running. \$150. 5 miles east of US-27, 1/2 mile north off M-57 on McClelland. Ashley. 17-3-p-27

KEEP CARPET cleaning problems small... use Blue Lustre wall to wall. Rent electric shampooer. \$1.00. Dean Hardware, St. Johns. 17-1-p-27

USED BLACK and white TV Console. \$60.00. Call at Ovid Hardware. 17-1-p-27

22 New spike shovels, 11 sweeps for Graham Hoeme plows below wholesale prices. Sportmate all steel trailer-new condition & Burroughs cash register & adding machine combined. 224-2163. 17-1-p-27

FOR SALE — Davenport and chair. Good condition. 113 Lewis St. St. Johns, Mich. Phone 224-7166. 17-1-p-dh-27

FOR SALE — Sears air conditioner, 6,000 BTU, 3 speed auto. Used 3 weeks. Ph 332-5349. 17-3-p-27

LET US RECOMMEND a painter or paper hanger for you. Your Sherwin Williams Dealer, Finkbeiner's, Fowler. Phone 593-2606. 41-1f-27

CLARINET FOR SALE — 4 years old, with case. \$90.00. Mrs Joe Teremi. 834-5127. 16-3-p-27

2-bedroom luxury apartment. New shag carpeting, individual storage space, central air conditioning from \$165 a month. 205 N. Scott Rd. St. Johns. Call 224-4376. Scott Rd. Apartments. 1f

LOOKING FOR A NEW HOME? We'll Build You What You Want

ON YOUR LOT OR OURS... WILLARD SEARLES Residential Builder ST. JOHNS Phone 224-3297

SIMON'S PLANING MILL Manufacturers of: Truck, pick-up, hay and grain racks, forage boxes, bunk feeders, portable cattle mangers and accessories. Custom woodworking. 268 S. Henderson Fowler, Michigan Phone (Area 517) 593-2000 E.O.W.

YOU SAVED and slaved for wall to wall carpet. Keep it new with Blue Lustre. Rent electric shampooer \$1.00. Dean Hardware, St. Johns. 16-3-p-27

WANTED — Riders to downtown Lansing, 8 to 5, or 7:30 to 4:30. Call after 6 o'clock, Pompeii 838-2505. 11-1f-dh-28

WANTED — Logs and standing timber. Logs delivered to our yard. DEVEREAUX SAWMILL, INC., 2872 N. Hubbardston Rd., Pewamo, Mich. Phone 593-2424 and/or 593-2552 40-1f-28

6-1973 MODEL SEW MACHINES \$41.50 — Slight paint damage in shipment. Only 6 left. Sew stretch material. Comes with a beautiful walnut sew table. Writes names and is fully equipped to zig-zag buttonholes. Makes fancy designs by inserting cams. Only \$41.50. Cash or terms arranged. Trades accepted. Call Lansing collect 489-2822 9 a.m. - 9 p.m. Electro Grand. 17-1-p-28

1973 HOOVER \$26.50 — Nice 2-tone Hoover cleaner. Used just a few times. All cleaning tools included. Only \$26.50. Cash or terms. Call Lansing collect 489-2822 9 a.m. - 9 p.m. Electro Grand. 17-1-p-28

CHRISTMAS IN AUGUST! DATE YOUR TOPS IN TOYS party now! Beautiful free catalogs include complete line of Fisher-Price and other brand name toys. Also Dealers Wanted. Phone Roberta Kelley at 224-6023. 14-4-p-27

YOU DULL 'EM, WE SHARPEN. WE SHARPEN SAWS SCISSORS TOOLS "CHAIN SAWS TOO" JIM'S SAW SHOP 613 S. Main St. Ovid. Back of Standard Station. Precision Workmanship. Speedy service. Popular prices. Retooling - Polishing - Gunning. 15-4-p-27

FOR SALE — 8' x 16' drive on scale. 20,000 lbs. capacity. Ph. Maple Rapids 682-4251 or see at 120 E. Main St. 15-3-p-27

TUB ENCLOSURES — Folding, polyvinyl doors - \$29.88. Dean True Value Hardware, St. Johns, Ph. 224-3271. 16-8-27

EAVES TROUGH — Galvanized, half round and galvanized or painted square. Complete line of fillings. Dean True Value Hardware, Ph. 224-3271, St. Johns. 16-6-27

SUMP PUMPS — 4 styles - good quality, as low as \$39.88. Dean True Value Hardware, St. Johns, Ph. 224-3271. 16-10-27

SHALLOW or deep well water systems at True Value prices. Dean True Value Hardware. Ph. 224-3271, St. Johns. 16-6-27

OIL SPACE HEATERS — 35,000 50,000 65,000 BTU sizes. Dean TRUE Value Hardware, St. Johns. 16-6-27

Hardware, Ph. 224-3271. St. Johns. 16-4-p-27

Wanted Miscellaneous 28
WANTED — Riders to downtown Lansing, 8 to 5, or 7:30 to 4:30. Call after 6 o'clock, Pompeii 838-2505. 11-1f-dh-28

WANTED — Logs and standing timber. Logs delivered to our yard. DEVEREAUX SAWMILL, INC., 2872 N. Hubbardston Rd., Pewamo, Mich. Phone 593-2424 and/or 593-2552 40-1f-28

6-1973 MODEL SEW MACHINES \$41.50 — Slight paint damage in shipment. Only 6 left. Sew stretch material. Comes with a beautiful walnut sew table. Writes names and is fully equipped to zig-zag buttonholes. Makes fancy designs by inserting cams. Only \$41.50. Cash or terms arranged. Trades accepted. Call Lansing collect 489-2822 9 a.m. - 9 p.m. Electro Grand. 17-1-p-28

1973 HOOVER \$26.50 — Nice 2-tone Hoover cleaner. Used just a few times. All cleaning tools included. Only \$26.50. Cash or terms. Call Lansing collect 489-2822 9 a.m. - 9 p.m. Electro Grand. 17-1-p-28

CHRISTMAS IN AUGUST! DATE YOUR TOPS IN TOYS party now! Beautiful free catalogs include complete line of Fisher-Price and other brand name toys. Also Dealers Wanted. Phone Roberta Kelley at 224-6023. 14-4-p-27

YOU DULL 'EM, WE SHARPEN. WE SHARPEN SAWS SCISSORS TOOLS "CHAIN SAWS TOO" JIM'S SAW SHOP 613 S. Main St. Ovid. Back of Standard Station. Precision Workmanship. Speedy service. Popular prices. Retooling - Polishing - Gunning. 15-4-p-27

FOR SALE — 8' x 16' drive on scale. 20,000 lbs. capacity. Ph. Maple Rapids 682-4251 or see at 120 E. Main St. 15-3-p-27

TUB ENCLOSURES — Folding, polyvinyl doors - \$29.88. Dean True Value Hardware, St. Johns, Ph. 224-3271. 16-8-27

EAVES TROUGH — Galvanized, half round and galvanized or painted square. Complete line of fillings. Dean True Value Hardware, Ph. 224-3271, St. Johns. 16-6-27

SUMP PUMPS — 4 styles - good quality, as low as \$39.88. Dean True Value Hardware, St. Johns, Ph. 224-3271. 16-10-27

SHALLOW or deep well water systems at True Value prices. Dean True Value Hardware. Ph. 224-3271, St. Johns. 16-6-27

OIL SPACE HEATERS — 35,000 50,000 65,000 BTU sizes. Dean TRUE Value Hardware, St. Johns. 16-6-27

Notice 29
FOR SALE — Parts for all electric shavers. Levey's Jewelry, Elsie. 1-1f-29

BEAUTIFUL WEDDING invitations and accessories. Speedy service, Finkbeiner's Fowler. Ph. 593-2606. 41-1f-29

MIKE'S SECOND HAND STORE — 5 miles east of US-27, 1/2 mile north off M-57 on McClelland Rd. 15-3-p-29

WANTED YOUR HEART — To be filled with joy of giving. Clothes, furniture, mattresses, food, your support — anything! From your home or business — to another in need — Don't throw it away!! Call C.Y.R.A.E. (517) 224-4537. 16-3-p-29

ALSO BOOKING PARTIES Don't delay! Call COLLECT! Ask for Marion, 1 (203) 673-3455. For write SANTA'S Parties, Inc., 18 Avon, Conn. 06001.

FANTASTIC TOY & GIFT LINE! 1973 - OUR 28th YEAR HIGHEST COMMISSIONS LARGEST SELECTION

No Collecting No Delivering No Cash Investment

ALSO BOOKING PARTIES Don't delay! Call COLLECT! Ask for Marion, 1 (203) 673-3455. For write SANTA'S Parties, Inc., 18 Avon, Conn. 06001.

FANTASTIC TOY & GIFT LINE! 1973 - OUR 28th YEAR HIGHEST COMMISSIONS LARGEST SELECTION

No Collecting No Delivering No Cash Investment

ALSO BOOKING PARTIES Don't delay! Call COLLECT! Ask for Marion, 1 (203) 673-3455. For write SANTA'S Parties, Inc., 18 Avon, Conn. 06001.

FANTASTIC TOY & GIFT LINE! 1973 - OUR 28th YEAR HIGHEST COMMISSIONS LARGEST SELECTION

No Collecting No Delivering No Cash Investment

CONCRETE WALLS

A new home is a lifetime investment. Let us help you secure this investment with the best basement wall possible - a poured concrete wall. We are equipped to do the complete job or any part of it. Bring your prints over or call for an appointment 587-3811.

READY-MIX CONCRETE For All Your Needs QUALITY-SERVICE

FEDEWA BUILDERS, Inc.
6218 Wright Road, 5 1/2 Miles South of Fowler.

AGRICULTURAL-INDUSTRIAL-LAWN & GARDEN EQUIPMENT Leasing-Rentals-Service-Parts "Home Of The Friendly People" **MORTON FORD TRACTOR, INC** 5122 North Grand River Lansing, Mich. 517 485 4355

STEVE'S REFUSE SERVICE

(Licensed Refuse Service) **OVID-ELSIE ST. JOHNS, EUREKA AND BANNISTER AREA.**

Commercial and Container Service **PHONE 834-5539** 4007 Carland Rd. Elsie, Mich.

USED TRACTORS

- JD 4620 Dsl, cab, heater, Ciar Cond, Duals, 300 hours.
- JD 4020 Dsl with cab
- JD 4020 Gas
- JD 2010 RU Gas with #36A Loader
- JD model 60 with live P.T.O. & Hydraulic
- John Deere "A" (two to choose from)
- John Deere Late Model "B" (two to choose from)
- Farmall Super C with wide front
- Farmall 400 gas
- Farmall 806 Dsl.

USED EQUIPMENT

- JD 55 S.P. Combine, grain platform, pickup & bean header.
- AC #60 pull type combine with engine, with pickup (for grain or beans)
- I.H.C. Model 650 field chopper w/two row corn head.

DON SHARKEY
John Deere Sales & Service
1 1/2 Miles East of St. Louis
Phone 681-2440

AL GALLOWAY

USED FARM EQUIPMENT
TRACTORS - COMBINES - CORNHEADS
TILLAGE TOOLS - PLANTERS - PICKERS
TRACTOR PARTS - REBUILT HEADS
GOOD SELECTION AT ALL TIMES
Phone (517) 224-4713 or 224-4300
First Farm North of St. Johns on US-27
ST. JOHNS, MICH.

IT PAYS TO LEASE-A-CAR
DAY, WEEK, MONTH or LONG TERM LEASE
CAINS, Inc.
BUICK-PONTIAC OPEL-GMC
210 W. Higham 2-1f

PUBLIC AUCTION SUNDAY AUG. 26 2 P.M.

Located at 307 N. Clinton Ave. - St. Johns
Everything Must Go!

THIS IS JUST A PARTIAL LISTING. MANY, MANY OTHER ITEMS TOO NUMEROUS TO MENTION!

- Not responsible for accidents during day of sale or goods after sold. Terms of sale are cash. Buyers come early, selling by numbers. Due to rain or bad weather sale will be held under cover.
- ANOTHER SALE CONDUCTED BY LEMON'S AUCTION SERVICE, LANSING.
- Chest of drawers
- Brass bed
- Apartment size refrigerators
- Stoves
- Washer and Dryer
- Couch & chairs
- Bedroom suites
- Anvil
- Lamps
- Approximately 25 shotguns and rifles
- An old horse buggy in beautiful shape!
- Antique pump organ
- 1967 Chevrolet 1/2 ton pickup

CALL FOR YOUR FALL SALE DATES . . . LANSING (area code 517) 882-0944

CARL S. OBERLITNER
Water Well Drilling
4" and larger
Reda Submergible Pumps
Wholesale Retail
Phone 463-4364
Alma 36-EW-1f

TRACTORS
MF 1100 Diesel with Duals
MF 65 Diesel w/13.6 x 38 tires
MF 65 Diesel-Matic w/Superior Industrial Loader
MF 165 Gas High Clearance w/Superior Industrial Loader
MF 180 Diesel w/15.5 x 38

OTHER EQUIPMENT
AC 12 ft. Wheel Disc
Gehl 2 Row Chopper
Gehl Forage Box w/Running Gear
2 IHC No. 76 Combine
JD 30 Combine
IHC No. 37 Baler, 3 years old
Lockwood Innes 6 row front puller
Innes 500 wind rower

Sattler & Son, Inc.
Phone 236-7280 Middleton

NORTHERN ROOFING & SIDING
121 E. STATE ROAD LANSING, MICHIGAN
MICHIGAN'S LARGEST INSTALLERS OF VINYL COATED STEEL SIDING INVITES COMPARISON!

- Doesn't dent like aluminum siding!
- Doesn't break like vinyl siding!
- 30-year transferrable Guarantee
- Also, a Workmanship Guarantee for 5 years

NO MONEY DOWN FINANCING AVAILABLE
Call 224-3590
for local representative or call COLLECT 487-5955
FREE ESTIMATE WITHOUT OBLIGATION TO BUY

YOUR VALUE LEADER

IGA

MARON'S

IGA

IN OVID

FOOD IS STILL AN HONEST VALUE

YOU SAVE 30¢ 10¢ OFF Label LAUNDRY DETERGENT 49¢ COLD POWER 49¢

YOU SAVE 20¢ COFFEE 'Reg., Drip, Elec. Perk' 1.59 MAXWELL HOUSE 1.59

YOU SAVE \$1.20 POLAROID #108 3.79 COLOR FILM Each

BUYING POWER Offers Your Best Value

NOTE: Not responsible for errors made in printing. QUANTITY RIGHTS RESERVED.

PRICES GOOD NOW thru SAT., AUG. 25, 1973

FAME ALL MEAT SKINLESS FRANKS 99¢ lb.

IGA-TABLERITE SHANK PORTION SMOKED HAM 88¢ lb.

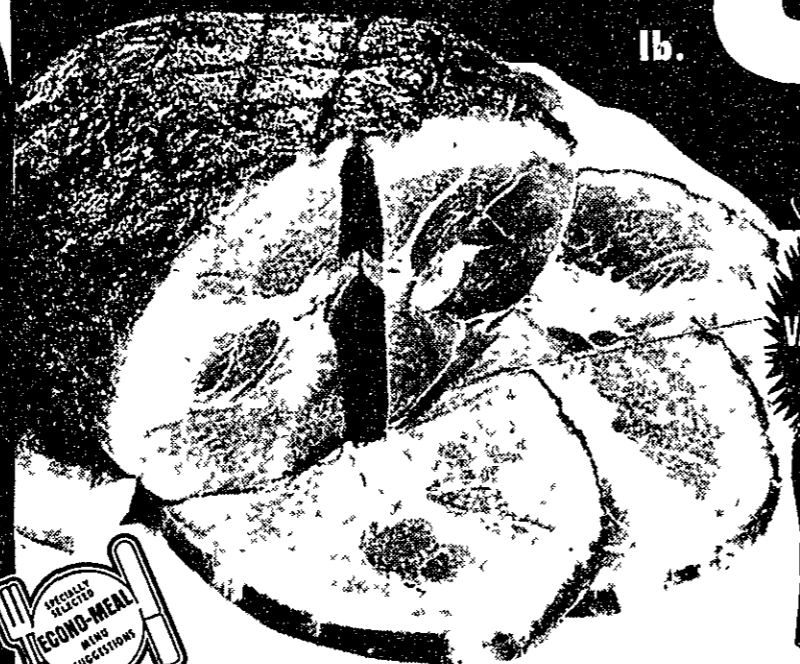

IGA-TABLERITE SMOKED HAMS 'BUTT PORTION' 98¢ lb.



Round STEAK \$1.29 lb.

Tabletite T-BONE STEAK \$1.49 lb.

SIRLOIN STEAK \$1.39 lb.

FRESH PRODUCE VALUES FROM IGA MICHIGAN GOLDEN PEACHES 29¢ lb. Honey Rock MELONS 39¢ Each CARROTS 39¢ 2-1 lb. Bags California White Seedless GRAPES 49¢ lb.

VAL-U-BUY OF THE WEEK! MAXWELL HOUSE COFFEE 1.59

CUT GREEN BEANS YOUR CHOICE 14¢

VAL-U-BUY OF THE WEEK! CAMPBELL'S TOMATO SOUP 10¢

LIBBY DEEP BROWN PORK & BEANS 25¢

VAL-U-BUY OF THE WEEK! SMUCKER STRAWBERRY PRESERVES 49¢

PENN. DUTCH MUSHROOMS 49¢

VAL-U-BUY OF THE WEEK! DILL PICKLES 59¢

STAR-KIST LIGHT CHUNK TUNA 39¢

VAL-U-BUY OF THE WEEK! COLD POWER 49¢

Bounty PAPER TOWELS 2/59

Facial Tissue 31¢, BROWN SUGAR 39¢, SANDWICH BAGS 29¢

FAME CATSUP 22¢, FAME MUSTARD 27¢, DEL MONTE SNACK PACK 59¢

ROMAN FABRIC SOFTENER 59¢, COFFEE CREAMER 63¢

LIL' FRISKIES CAT FOOD 1.19, FAME NOODLES 28¢

PATES VARIETY PAK 69¢, SUNSHINE COOKIES 54¢, FAME DOG FOOD 89¢

POLAROID No. 108 COLOR FILM 3.79

TOOTH PASTE GLEEM 68¢

FLASH CUBES 69¢

FOOD IS AN HONEST VALUE

OVEN FRESH NUTTY DONUTS 49¢, WHITE ENRICHED BREAD 85¢

RAISIN BREAD 59¢, HAMBURG & HOT DOG BUNS 35¢

FROZEN FOOD VALUES

BORDEN'S TOFFEE BARS 39¢, ORANGE JUICE 99¢

VAL-U-BUY OF THE WEEK! Borden's COTTAGE CHEESE 53¢

FRESH DAIRY VALUES: FAME 2% LOW FAT MILK 99¢, ORANGE JUICE 49¢, MARGARINE 47¢, CHEDDAR CHEESE 89¢, CHUNK CHEESE 1.49, BUTTER 83¢

EVERYDAY LOW PRICES: ORE-IDA POTATO SPECIALTIES 47¢, JOHN'S PIZZA 89¢, FAME GRAPE 'A' FROZEN SLICED STRAWBERRIES 33¢, FAME FROZEN CUT ASPARAGUS 55¢

THE GINGERBREAD HOUSE — 206 W. Walker, will open early September for day care and nursery school. Children 3 to kindergarten, full or half day sessions. Certified teachers, state licensed. Call Mrs. Joan Valentine, 224-3581 for more information. 16-3-p-29

GOSPEL CONCERT — with the Gospel Troubadours, Ithaca Fall Festival, Saturday Aug 25, 1973, 8:30 pm behind Ithaca Commercial Nat Bank. 16-2-dh-29

FOWLER RESIDENTS — Take your ads to Finkbeiner's Pharmacy for fast, convenient service! 50-dh-tf-29

"CULTIVATED BLUE-BERRIES" — Pick your own or ready picked. Open 7 days a week 8 a.m. till dark. Excellent picking. Phone 794-0348 or 754-3684. Belding north 3 miles on M-91. **BIRD BLUEBERRY PLANTATION.** 13-tf-29

YOU CAN build a new home and finance it at 7-1/4% interest with low monthly payments and very small closing costs if you qualify. Under this plan you can build a 3 or 4 bedroom home. If you can't qualify for this financing program, we have other financing programs available which can be adapted to your budget. For

more information, call Fedewa Builders, Inc. 587-3811 or stop in at our office located 5-1/4 miles south of Fowler on Wright Rd. 27-tf-29

THERE IS NOW a Timex Repair Service in Michigan. Free estimates will be sent on all repairs, do not send money. We also repair all other makes of watches. Please send watches to Timex Repair Service, P.O. Box 128, Kinde, Mich. 48445. 40-tf-29

NOTICE — Y.W.C.A. Antique Show, 621 W. Oliver St., Owosso, Michigan on September 13 and 14 from 11:00 a.m. to 9:00 p.m. 17-2-p-29

FRANCIS AVIATION, INC. — Travel the safe way with our charter service or learn to fly with us. Vets approved. Capitol City Airport - Ph. 484-1324. 23-tf-29

CUSTOM BUTCHERING AND PROCESSING. We butcher on Wednesdays and Fridays. Beef-Pork. Halves and quarters, also retail cuts. All meats MDA inspected. Pendell's Meat Processing. West City Limits on Bussell Rd. just off M-57, Carson City. Phone 584-6640. Jake Vaughn. 5-tf-nc-29

ANNOUNCING new hours. Monday through Friday 8 a.m. to 5 p.m. Saturday 8

a.m. to 12 noon. Grinding feed and receiving grain. Laingsburg Farm Service. 651-5250. 12-tf-29

PLAN TO ATTEND THE OUTDOOR DANCE. Listen to the sounds of "Risintime" at Fink Field (little league field) August 25 from 8:30 p.m. to midnight. Sponsored by the Fowler Jaycees. 17-1-p-29

PIANO TUNING — Herbert DePeal. Call 224-6149 or 224-3134 days only. 17-3-p-29

I WILL BE tuning pianos full full time and will take appointments for the winter months. Herbert DePeal. Call 224-6149 or 224-3134 days only. 17-3-p-29

PARENTS — Please check your sons baseball gloves. One with the owners name on it was taken August 6 in front of Heyer's store, Westphalia after a Little League game. Please return to Heyers. 17-1-p-29

LOOK! LOOK!

We know of no better way of showing Solid Proof of Customer Satisfaction QUALITY — PRICE — EXPERT INSTALLATION

NO BIG FANCY COME ON ADS — NO EXPENSIVE ADVERTISING — LOW OVERHEAD

Bring in Your Room Size and Get Our Price!

Feel FREE to CHECK with Any of Your Neighbors

Rosemary Burns, 209 N. Church, St. Johns
Myron Scot, 7700, Grand River, Laingsburg
Lloyd Koerner, 6340 Brewer Rd, Laingsburg
Robert Kirkbride, W. Colony Rd, St. Johns
Darrell Marten, Route 5, St. Johns
Winford Mabie, 204 N. Mead, St. Johns
Robert Dennis 8715 E. Alward, Laingsburg
William Coffman, Lansing St, St. Johns
Mildred Bradley, R 2, Ashley
Dave Paski 304 S. Mead, St. Johns
Ron Woodruff, 3260 E. M-21, St. Johns
William Bellant 407 S. Baker, St. Johns
Elmer Leydorf, 217 N. 3rd St, Bannister
Janet Pope, 305 N. Prospect, St. Johns
Mr. J. Austin 7370 W. Garrison Rd, Laingsburg

Fred Fatura S. Mason Rd, Bannister
Kirby Sales 705 N. U.S. 27, St. Johns
Charles Lapham Route 6, St. Johns
Gerald Ranshaw 106 E. Gibbs St, St. Johns
Robert Darling 304 N. Kibble, St. Johns
Melsin Thrum 1650 E. French Rd, St. Johns
Dale Peck 10160 Gratiot Countyline Rd, St. Johns
David Arnst Route 1 Bannister
Jack Love 10820 E. , Fowler
William Buggs 4472 U.S. 27, St. Johns
Mrs. Pilot Route 1, Bannister
Lawrence Fivecoat 6612 Windfield, Sheppardsville
Mrs. Forrester 7180 W. Garrison Rd., Laingsburg
Mrs. Beckman 621 E. North St, Oakley
Mr. Havens 3916 Watson Rd, St. Johns

Complete Line Of **WALL & FLOOR CERAMIC**

BUY

Complete Line Of **WALL & FLOOR CERAMIC**

Your Carpet Locally and Get Service after the Sale - If Needed

Bring in Your Lowest Estimate and Let Us Try To Beat It!

QUALITY - NAME BRAND CARPETS AT LOW - REASONABLE PRICES! GUARANTEED - INSTALLATIONS!

100% Nylon **CANDY STRIPE** With Pad **\$5⁹⁵** Sq. Yd.

100% Commercial **RUBBER BACK** Cut and Lay **\$3⁹⁵** Sq. Yd.

Armstrong

FLOORING OWOSSO STORE

2090 W. Main Phone 725-8169

250 ROLLS IN STOCK Ready For **IMMEDIATE INSTALLATION**

Don't Wait

Town & Country Carpets

312 N. CLINTON

ST. JOHNS

FOR A NO CHARGE ESTIMATE CALL

Out of Town Call Collect

STORE HOURS: Mon. and Fri. - 9 to 9 Tues., Wed., Thurs., Sat. - 9 to 6

224-6456

Card of Thanks 30

Card of Thanks

Thanks to all you "beautiful people" for the wonderful going away parties and the gifts that you have given us. To name just a few; The P.W. Gun Club; Friends, neighbors, old 4-H Leaders, old 4-H members of Old Prairie 4-H Club. It has been fun and we have had a ball. Thanks again. E.J. and Freda 17-1-p-30

BEACH — I wish to thank my neighbors, relatives and friends for their calls, cards, flowers, gifts and the many acts of kindness shown during my recent stay in the hospital. My special thanks to the First Congregational Church, the Priscilla Alden Division, our Pastor, Al Carson for his call, Radiant Chapter #790 ES and the American Legion Auxiliary. I deeply appreciate your thoughtfulness. Bernice Beach 17-1-p-30

COOK — Mrs. Bruno Cook and family are truly grateful for the many masses, prayers, and flowers sent to Dr. Cook at the time of his death. 17-1-p-30

Kincaid

Thursday, Mr and Mrs Donald Sullivan, Mrs Raymond Sherman and Kevin of Grand Ledge and the Wooster girls of Francis Road went swimming at Round Lake.

Dan Sullivan spent the weekend with friends at Horsehead Lake.

Mr and Mrs Donald Sullivan visited Mr and Mrs George Balli of Ionia, Saturday evening.

Garry Sullivan and friend returned Sunday from a trip to Canada.